



CENTRAL BOILER OUTDOOR FURNACE INSTALLATION AND INITIAL WATER TREATMENT GUIDE

Some of the information provided in this guide is for reference only. Your actual furnace may differ from those represented here. ALWAYS refer to your Owner's Manual for information specific to your furnace.

For parts and accessories, service or repairs, call your authorized Central Boiler dealer or heating contractor. Record the information below for future reference.

Model	Serial Number	Installation Date
Dealership Name		Phone Number
Owner Name		

SAVE THESE INSTRUCTIONS

(p/n 9000800 - REV. E)

Contents

How to Use This Guide

The guide is divided into sections to help with the installation of the outdoor furnace and connection to an existing heating system. The information provided here represents common installations, components and heat emitters. Every system will be different. If questions arise that are not answered with this guide, consult with your dealer and/or a heating professional.

Important Precautionary Information	iv
PLANNING THE LOCATION	1
INSTALLATION PRECAUTIONS	2
Chimney Recommendations	2
GENERAL INSTALLATION INFORMATION	3
Potable Water	3
MolyArmor 350 Corrosion Inhibitor	3
Adding Antifreeze to Outdoor Furnace System	4
Shut-Off Valves	5
Ground Rod Kit	5
Supply and Return Lines	5
Temporary Above Ground or Winter Installations	6
Digging the Trench	6
Electrical Connection	7
Connecting to Existing Heating System	8
SYSTEM COMPONENTS	9
Plan with your heating system in mind	9
Pump Selection	9
Pump Installation Guidelines	10
Selecting Pump Location	11
Ports on Outdoor Furnace	13
PEX Fittings and Tools	13
Shut-off Valves	14
Optional Thermostatic Valve	14
Manual Air Bleeders	15
CONNECTING TO EXISTING SYSTEMS	16
Water Heater	16
Existing Forced Air Installations	18
Water Flow	18
Items of Note in Forced Air Installations	18
Installing Thermostatic Controls for Forced-Air System	21
Heating Multiple Zones	25
Hydronic Systems	26
Filters	26
Evaluate Your Existing System Before Installation	26
Connecting to an Existing Boiler System - Pressurized	27
Connecting to an Existing Boiler System - Vented	29
Connecting to Hydronic Baseboard Heaters	31
Hydronic Radiant Systems	33
Pool and/or Hot Tub Heating	38
FINALIZING THE INSTALLATION	39
1. Test Supply Water	39
2. Check the Vent Cap	39
3. Check for Leaks	39
4. Cover Supply and Return Lines	40
5. Adding Initial Water Treatment	40
6. Fill Outdoor Furnace with Water and Purge Air	41
7. Immediately Heat the System Water to 185°F (85°C)	46
8. Test the Treated System Water	47
9. Titanium Series Models - Send in Water Sample	47

Important Precautionary Information

Be sure to read carefully and understand these precautions before, during and after the installation, operation and maintenance of the furnace.

NOTE: All installations must be in accordance with local and state codes which may differ from the information in this manual.

NOTE: Any electrical installation should be done by a qualified installer in accordance with applicable codes.

NOTE: Any changes to an existing boiler system should be done by a qualified installer in accordance with applicable codes.

⚠ WARNING

Do not attempt service inside the electrical control panel without first disconnecting the electrical power at the main power source.

⚠ WARNING

This outdoor furnace is not intended or certified to be installed inside habitable space. Do not install the outdoor furnace inside your home.

⚠ WARNING

This outdoor furnace should not be installed in a building that could be damaged or where a financial loss could occur from smoke, soot, fire or water.

⚠ WARNING

This outdoor furnace and/or chimney must not be installed inside or under any configuration or construction that contains combustible materials as part of the structure or configuration. The chimney is not intended or safety tested to be used or installed other than on the furnace located outside of any structure or enclosure.

⚠ WARNING

Disconnect the electrical power to the outdoor furnace before replacing an electrical component.

⚠ WARNING

When installing a heat exchanger on an existing hot water boiler or in a forced air system, be sure none of the existing system safety controls are disabled.

⚠ WARNING

Maintain the following clearances from combustibles for the furnace installation:

- 44" (112 cm) from the back
- 12" (30.5 cm) from the sides
- 48" (122 cm) from the front
- 18" (46 cm) from chimney inspection cover
- The foundation must be noncombustible
- Refer to your Owner's Manual for recommended maintenance clearances

⚠ WARNING

Do not allow combustible materials (straw, hay or wood) near the outdoor furnace. Keep the perimeter of the outdoor furnace clear and clean.

⚠ WARNING

For fire safety, keep all combustible materials at least six feet (two meters) away from the outdoor furnace, especially around the door area. Debris of wood chips and other combustibles in the area may be easily ignited if a hot coal is spilled out of the firebox and left unnoticed.

⚠ CAUTION

This outdoor furnace is not intended to be connected to a chimney flue serving another appliance.

PLANNING THE LOCATION

Before You Begin

To ensure your Central Boiler outdoor furnace functions as designed, careful planning and proper installation are imperative. This section outlines much of the information needed to install the outdoor furnace, select water lines, install circulation pumps and connect to your existing heat emitter(s).

Some of the information provided in this Installation Guide is for reference only. For example, illustrations of furnaces are meant to be for reference only; your actual furnace may be different.

Always refer to your Owner's Manual for information specific to your furnace.

Be sure to read carefully and observe all of the information, not only in this guide, but in the entire Owner's Manual.

If any installation questions arise that cannot be answered by the information in this manual, be sure to contact your dealer.

When selecting a suitable location, carefully consider each of the following:

- Must be installed in accordance to all applicable codes and regulations.
- Check with your insurance company to see if they have any location requirements.
- Consider prevailing winds and the direction smoke will travel.
- The shorter the distance between the outdoor furnace and building(s) being heated, the lower the cost will be for the installation of the hot supply and return water lines, and ThermoPEX piping.
- Be sure to maintain the required clearances to combustibles and recommended maintenance clearances.
- ThermoPEX pre-insulated piping is recommended for all installations. Other types of insulated pipe configurations may result in high heat loss and increased wood consumption.
- If the ground at the location is unstable or subject to frost heaving, consider installing 2" (5 cm) closed-cell insulation under the front portion of the concrete slab the outdoor furnace will be installed on, and under the area around the slab used for walking. Your Owner's Manual has more information about foundations and foundation dimensions.

Foundation or No Foundation?

Some outdoor furnaces may be installed without a concrete foundation, while some require a foundation (see your Owner's Manual). Even if a foundation is not required, installing the outdoor furnace on a foundation offers many advantages to placing it directly on stable, level ground. The outdoor furnace is less likely to move due to frost heaving. A foundation keeps the area directly around the outdoor furnace free of standing water and can help to keep unwanted pests out. It can also raise the furnace up to provide a more comfortable height of the firebox door opening.

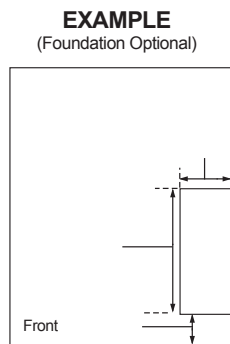

CAUTION
Do not use any combustible materials for the foundation.

Outdoor furnace must be installed on a noncombustible surface or foundation that incorporates an enclosure that will prevent supply and return lines from possible exposure to sunlight, fire, or physical damage that may be caused by an occurrence outside the outdoor furnace enclosure. Foundation may consist of concrete, crushed rock, or patio blocks.

This is an example of a foundation illustration. See your Owner's Manual for foundation information for your model.

INSTALLATION PRECAUTIONS

A qualified installer must perform the installation of this supplementary outdoor furnace and must determine how to install it to be compatible with the existing heating source.

Chimney Recommendations

NOTE: Chimney recommendations provided here are general in nature. You should refer to your Owner's Manual for model-specific recommendations and requirements.

In higher populated areas, extend the chimney to a height above the roofs of surrounding buildings. Use Central Boiler Chimney Extensions when extending the chimney. When only the standard eight feet (2.4 m) of chimney are used, the sections must be secured at the connection joint with four (4) screws to stabilize the extension.

If extensions are added to the standard eight feet (2.4 m) of chimney, the chimney should be reinforced appropriately. Refer to the Owner's Manual for chimney support recommendations when three or more sections are used. When adding sections of chimney, make sure that there is nothing within the fall zone of the chimney that could be damaged. If something is located within the fall zone and cannot be removed, guy wires or braces may need to be installed to prevent a falling chimney from causing damage.

NOTE: If more than three 4-foot (1.2-m) sections of chimney are used, a support (e.g., a pole, pipe or other structural support) may be installed from the ground that can withstand wind.

NOTE: For chimney extensions or chimney replacement, use only genuine Central Boiler chimney components. Parts are available from an authorized Central Boiler dealer.

The installation of a spark arrester is recommended, particularly where there are dry conditions or where there is combustible material near the unit, unless the installation of a spark arrester is prohibited by local requirements. Use common sense to avoid potential fires, including exercising caution when disposing of ashes, cleaning and refueling. Keep all highly combustible materials (e.g., gasoline, propane, leaves, pine needles, etc.) away from an operating unit at all times. Take special precautions in windy conditions.

If a spark arrester is used, it must be kept clean enough to allow unrestricted exhaust flow.

GENERAL INSTALLATION INFORMATION

Potable Water

If the outdoor furnace is to heat potable water associated with commercial food preparation or for heating milk-house hot water, it is recommended to install a double-wall heat exchanger. Also, when filling the system with water, a back flow preventer must be installed in the line used for filling.

MolyArmor 350 Corrosion Inhibitor

To aid in protecting the system from corrosion, it is imperative to add MolyArmor 350 Corrosion Inhibitor to the outdoor furnace immediately before it is filled with water. One of the ways the MolyArmor 350 water treatment works is to coat the metal with a layer of protectant. Not adding MolyArmor 350 before water is added (even within a matter of minutes) can allow corrosion to start that the MolyArmor 350 Corrosion Inhibitor may be unable to stop.

MolyArmor 350 Corrosion Inhibitor is composed of common materials. Molybdenum compounds are characterized as nontoxic in US Public Health Bulletin 293, by the Federal Hazardous Substances Labeling Act, and by the Occupational Safety and Health Act. However, in keeping with good safety and environmental practices, dispose furnace water in accordance with federal, state and local regulations.

- Unless regulation prohibits, you may drain the outdoor furnace to a home septic system. If doing so, however, be careful not to overflow the septic system.
- Do not drain the outdoor furnace in such a manner that the drain water could in any way contact surface water, stream, river, estuary (where a river meets a sea), lake, pond, ocean or other types of waters.
- Do not drain to any location within 50 feet (15 meters) of any water well.

MolyArmor 350 Corrosion Inhibitor

MolyArmor 350 Corrosion Inhibitor provides superior water jacket and pump protection when maintained at recommended levels. It also provides for easy testing of treated water; no messy chemicals are needed.

Adding Antifreeze to Outdoor Furnace System

Most outdoor furnaces are installed *without* antifreeze when an existing heating system is in place and there is no anticipation of leaving the outdoor furnace unattended for extended periods of time (10 days or more). If the building being heated has an alternate heat source, system water may be kept from freezing by running the circulating pump(s) and drawing heat from the existing furnace or boiler in the home or building.

To prevent freezing if the outdoor furnace is not fired for extended time periods or if lengthy power outages are anticipated during cold weather, a nontoxic propylene glycol may be used in the system. Some types of antifreeze that contain various inhibitors have been known to create problems like coagulation and jelling. To prevent potential problems, **do not use propylene glycol that is premixed with inhibitors.**

MolyArmor 350 Corrosion Inhibitor is compatible with (raw) propylene glycol. It is important to use MolyArmor 350 Corrosion Inhibitor with straight propylene glycol for corrosion protection. If adding antifreeze to the system, it is imperative that the entire system contain **at least 30% antifreeze concentration mixed with water that is 6.5 to 8.0 pH. Softened is recommended, if available. Do not use reverse osmosis or deionized water** that has very low pH. Bacterial growth is likely to occur with low antifreeze concentrations and can cause corrosion in the furnace water jacket and/or clogging of heat exchangers. To confirm the antifreeze solution is adequate and to kill bacteria, immediately heat the system up to 185° F, allow the pumps to circulate for at least 24 hours and then obtain a sample of the system water. Using an antifreeze tester, the solution must be protected to 10° F (-12° C) or below.

NOTE: If using antifreeze, test the pH and Moly levels once each month. If the bacterial issues occur, the pH will decrease.

NOTE: Be sure to adhere to all warnings and precautions on the antifreeze label.

NOTE: Do not use automotive or RV types of antifreeze.

NOTE: If using antifreeze, see Water Quality and Maintenance in your Owner's Manual.

Shut-Off Valves

Shut-off valves must be installed on each hot supply and return water line so each line can be shut off individually for purging air from the system. Be sure all valves and fittings are metal. **Do not use plastic valves or fittings.**

Ground Rod Kit

If required, the outdoor furnace must be electrically bonded to ground in accordance with the requirements of the authority having jurisdiction or, in absence of such requirements, with the National Electrical Code, ANSI/NFPA 70 and/or the Canadian Electrical Code Part 1, CSA C22.1 Electrical Code.

Install a Ground Rod Kit (p/n 6593) and connect it to the outdoor furnace. Refer to your Owner's Manual for more information.

Supply and Return Lines

Determine the configuration of the supply and return lines from the outdoor furnace to where the supply and return lines will connect to the existing heating system. Central Boiler recommends using the ThermoPEX® piping system.

ThermoPEX is a fully assembled, pre-insulated piping system consisting of two 1" PEX, 1-1/4" PEX or 25mm PEX lines. The two lines (one a supply and one a return line) are insulated with high-density urethane insulation and a thick, durable, waterproof, polyethylene outer jacket. One of the lines is marked with a black stripe for identification.

NOTE: To prevent ground water from entering the house, do not use drain tile, PVC pipe with bubble wrap, or any other inferior material for insulating the water lines.

NOTE: If the outdoor furnace supply and return lines are not insulated properly, or if other brands of insulated piping are used, there can be excessive heat loss. This heat loss can greatly increase the fuel consumption.

NOTE: If it is unavoidable that the trench will run through an area of ponding water, use ThermoPEX instead of other materials. ThermoPEX should also be used for above-ground or winter installations, and if the area is likely to be affected by compaction.

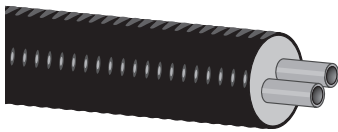

ThermoPEX® Advantage

ThermoPEX is flexible pre-insulated piping that is ideal for use with outdoor wood furnaces. ThermoPEX consists of two 1-inch* oxygen barrier PEX® lines, two 1-1/4 inch** oxygen barrier PEX lines, or two 25mm*** oxygen barrier PEX lines (a supply and a return line). The lines are insulated with high-density urethane insulation and a thick, durable, waterproof polyethylene outer jacket. Thermal expansion is absorbed within the system because the PEX lines, urethane insulation and the durable outer jacket are cast together. The corrugated design allows flexing for easier installation. ThermoPEX is a proven product and maintenance-free.

*CTS ASTM 1" supply and return.

**CTS ASTM 1-1/4" supply and return.

***CTS ASTM 25mm supply and return.

Risks of Inferior Piping

To prevent ground water from entering the house, do not use drain tile, PVC pipe with bubble wrap, or any other inferior material for insulating the water lines.

If the outdoor furnace supply and return lines are not insulated properly, or if other brands of insulated piping are used, there can be excessive heat loss. This heat loss can greatly increase the fuel consumption.

Temporary Above Ground or Winter Installations

For temporary above ground or winter installations in which the supply and return lines can not immediately be buried underground, Central Boiler recommends using ThermoPEX. Be sure that both the insulation and the supply and return lines will not be exposed to ultraviolet rays. The ThermoPEX black exterior jacket has UV protection but the insulation and water lines inside do not. Use a ThermoPEX termination cap at each end of the installation to protect and seal the insulation from water.

NOTE: Bury the ThermoPEX as soon as conditions permit (e.g., once the ground has thawed).

NOTE: If ThermoPEX is installed temporarily above ground, provisions should be made to prevent possible risk of fire coming into contact with the ThermoPEX. ThermoPEX is constructed of materials that can burn and transfer a fire.

⚠ CAUTION

If ThermoPEX is installed temporarily above ground, do not cover with combustible materials (e.g., straw, hay, leaves, etc.).

Digging the Trench

⚠ WARNING

Before digging, be sure to call for utility locator service.

The trench depth for ThermoPEX should be between 10" and 28" (25 and 71 cm).

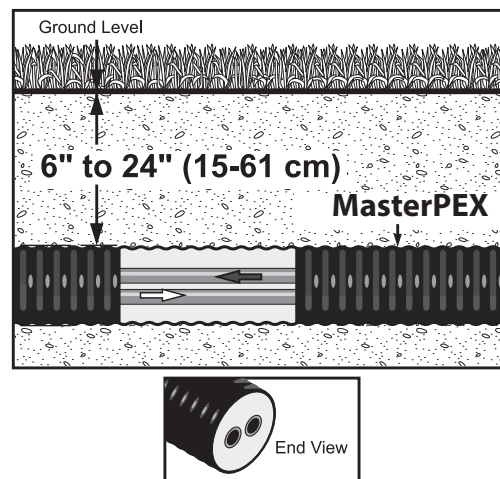

Electrical Connection

⚠ CAUTION

These procedures should be performed by a qualified individual and in accordance with any and all federal, state/provincial and local codes and regulations. When performing work on an appliance observe all precautions in the literature, tags and labels attached to the appliance and other safety precautions that may apply. When working with electricity and electrical components, failure to follow precautions could result in property damage, personal injury or death.

Remove the pump access cover and locate the power cord from the field wiring box (junction box). The power cord was temporarily installed from the factory and is not for permanent installation.

With the cord unplugged, remove the two screws from the plate covering the cord end and remove the cord. The cord can be repurposed for a circulator pump.

Connect the furnace wires to incoming 120V mains using lever connectors. With the plate in its proper location, install the two screws.

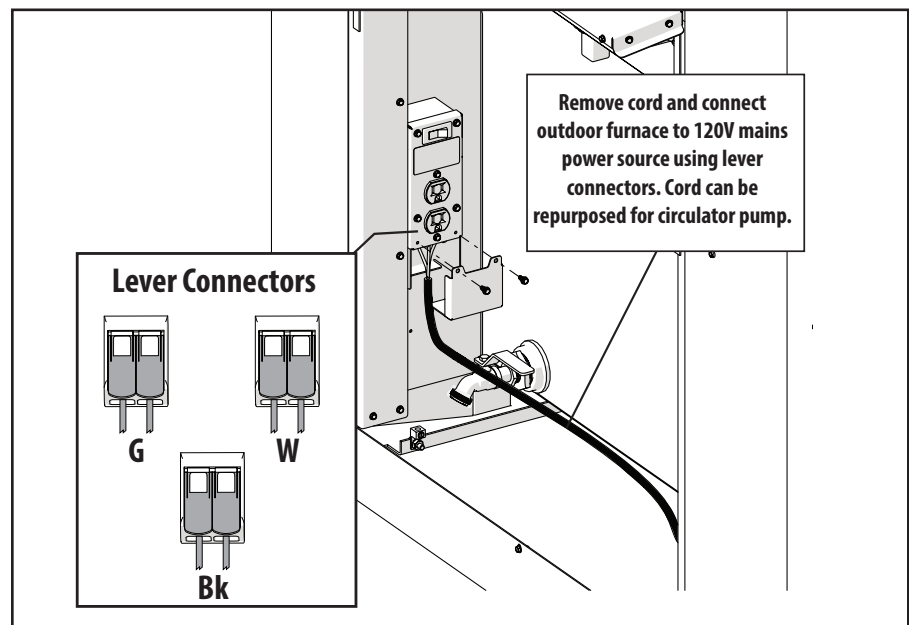

A 14-2 (two wires plus ground) underground rated wire should supply the outdoor furnace with electricity. A heavier gauge wire may be needed if the run is over 200 feet (61 meters). Check local codes and requirements. It is recommended that the incoming fuse or circuit breaker not exceed 15 amps.

Connecting to Existing Heating System

1. Make an entrance into the building(s) where the supply and return lines are to enter.
2. Lay the ThermoPEX assembly in the trench and feed one end into the building. Apply sealant around the supply and return lines where they enter the building.
3. Using compressed air, purge the supply and return lines before connecting any fittings to ensure there is no debris or foreign matter present.

NOTE: All holes made in basement or building walls must be sealed completely to prevent water from entering the building.

4. Close all valves on the outdoor furnace.
5. Install fittings to allow pressure-testing of both supply and return lines. Pressurize with 50 psi (3.5 kg/cm²) of air; then check after 30 minutes to see if pressure has dropped. A drop in pressure indicates a leak; repair as necessary.
6. Connect the supply and return lines to the outdoor furnace and to the inside system.

NOTE: See your Owner's Manual for more information about your furnace's supply and return line ports and connections.

⚠ CAUTION

Allow for expansion and contraction of the supply and return lines at each end. Without an allowance for expansion and contraction, the lines may kink or the fittings may be pulled apart, causing an immediate water loss from the outdoor furnace. PEX water lines can have an expansion and contraction rate up to .095" per each 100 ft and each 10°F (2.4 mm/30 m/5.5°C).

7. Make sure there are no leaks in the supply and return lines; then backfill the trench.

NOTE: Do not backfill the trench until the supply and return lines have been tested to ensure there are no leaks.

SYSTEM COMPONENTS

Plan with your heating system in mind

Spending time early thinking about how your outdoor furnace will tie into your heating system can save many headaches later on. In the next few pages, examples and illustrations are provided that show installations with many common types of heating systems. The information provided here is intended to be a guideline to ensure your outdoor furnace works as it should with your system. Because every system is unique, your actual installation will differ. If any questions arise that cannot be answered by the information in this guide, be sure to contact your dealer or HVAC professional.

Central Boiler provides a wide variety of components, fittings, tools and more to accommodate your furnace's installation and connection to your existing heating system. See your dealer for more information.

Pump Selection

When selecting a pump, it is important to correctly size it to work properly within the system. Some factors to consider are the diameter of the supply and return lines, total length of the supply and return lines, equivalent length of each component installed in series, and flow rates of the pump(s) at common equivalent lengths.

NOTE: If operating with system water at 195°F (91°C), it may be necessary to mount the pumps lower.

NOTE: See the Hydronic Component Selection Guide for more detailed information about pump selection.

Taco 0015e3 Circulation Pump

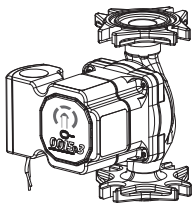

Taco Viridian VR1816 Circulating Pump

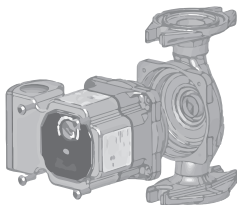

Taco Viridian VT2218 Circulating Pump



The Taco 0015e3 is a variable speed, high-efficiency wet rotor circulator with an ECM permanent magnet motor. It's ideal for hydronic systems zoned with circulators or zone valves, and features three easy settings: LOW (5 ft head), MEDIUM (10 ft head), HIGH (18 ft head). The 0015e3 has a maximum flow of 16 gpm.

The Taco Viridian VR1816 pump is an infinitely-variable speed, high-efficiency wet rotor circulator with an ECM permanent magnet motor.

The Taco Viridian VT2218 pump is a temperature sensing, variable speed wet rotor circulator with an ECM permanent magnet motor. Operating modes include Delta-T differential temperature, 4 fixed speeds, set point heat, set point cool and boiler protection.

Pump Installation Guidelines

The following guidelines must be adhered to when installing the circulation pump(s).

NOTE: The direction of water flow is very important for the proper operation of the outdoor furnace. Installing a swing check valve in the return line can prevent possible reverse flow.

Hydronic Component Selection Guide

An invaluable resource for selecting the correct hydronic heating components for your specific system. Available from your Central Boiler dealer.

NOTE: See the Hydronic Component Selection Guide for more detailed information.

⚠ WARNING

Maximum load of the outlet on the outdoor furnace is 10A, 120VAC, and 60Hz.

- The pump motor must be installed in a horizontal position.
- The junction box must not be located below the pump motor. If necessary, remove the four screws and rotate the pump body.

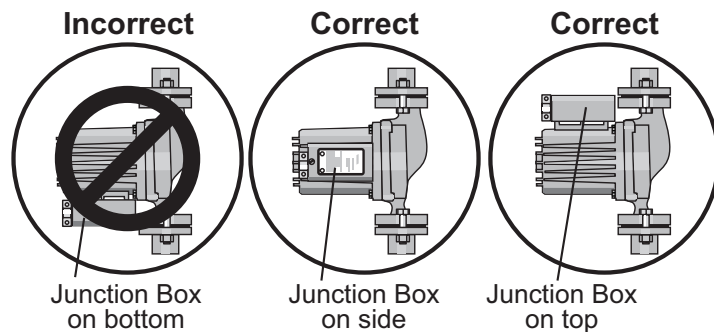

- Do not operate the circulation pump until the entire system has been filled with water, the system has been purged, and it has been checked for leaks or the pump may be damaged.
- Insulate the areas around the supply and return lines, pumps and drain valve; then install and secure the back panel.

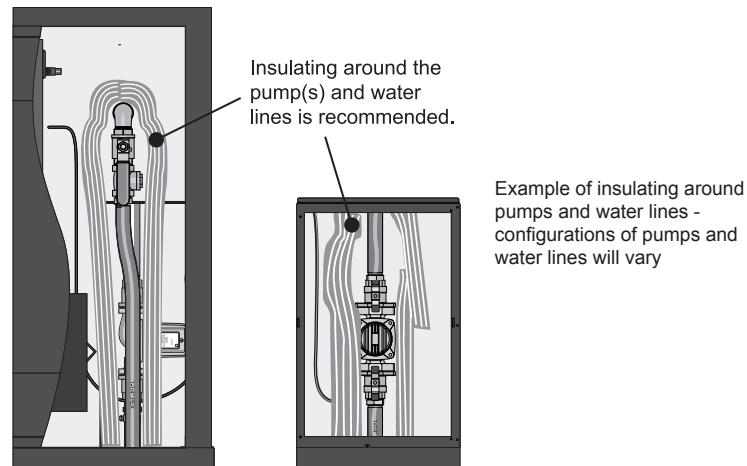

NOTE: At least one circulation pump must run continuously to ensure proper operation of the outdoor furnace.

- **The circulation pump(s) must be installed in the supply line(s) with the arrow on each pump pointed away from the outdoor furnace.** In order to avoid circulation problems, do not install the pump(s) in the return line(s).

Selecting Pump Location

- The pump(s) must be located near the base of the outdoor furnace if the system has a high-flow pump or very low resistance on the outlet side of the pump. For example, if the outdoor furnace is 20 feet (6 meters) from the building and pumping water through one-inch pipes, a 50-plate heat exchanger or water-to-air exchanger, and back to the outdoor furnace, the pump needs to be mounted with four feet of water above the pump.
- The pump(s) must be located near the base of the outdoor furnace if operating with water temperatures of 195°F. Water at 195°F will boil on the inlet side of the pump if there is not an adequate amount of water above the pump. This causes reduced flow rates, cavitation (indicated by a noisy, rattling pump) and results in premature failure of the pump.

- Depending on the system water temperature, four feet of water above the pump should be adequate for systems with higher resistance (e.g., longer loops with other fittings, elbows, heat exchangers). For systems with low resistance (e.g., short loops, larger diameter pipes and low resistance heat exchangers like a water-to-air exchanger), it may be necessary to mount the pumps with four to eight feet of water above the pump. **See the Hydronic Component Selection Guide for more information.**
- Installing the circulation pump(s) at the outdoor furnace is recommended, but required if the building being heated is higher than the outdoor furnace or if there is a large rise in the water lines between the outdoor furnace and building. Hot water boils at a lower temperature when pulled uphill (because it is at a lower pressure); therefore, hot water must be **pushed** uphill to ensure proper circulation.

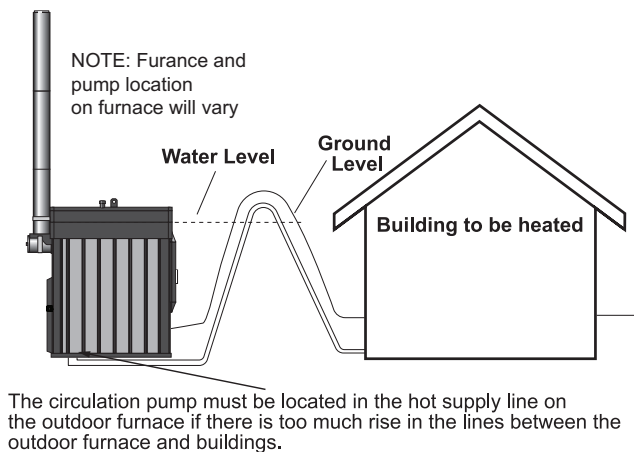
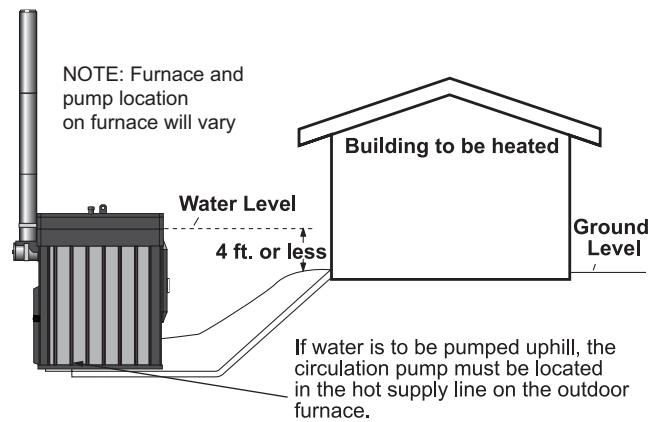

- When the pump is located in the building to be heated, maintain a minimum of 4 feet between the water level in the outdoor furnace and the highest point of the water line between the furnace and the building.

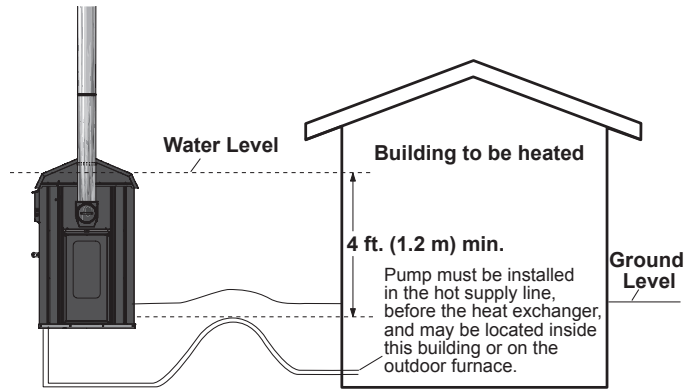

Ports on Outdoor Furnace

Refer to the Owner's Manual for information about supply and return ports, and for pump mounting locations on the outdoor furnace.

PEX Fittings and Tools

Central Boiler offers a wide selection of PEX fittings and tools for designing your hydronic system. Refer to the System Parts catalog or see your dealer for more information.

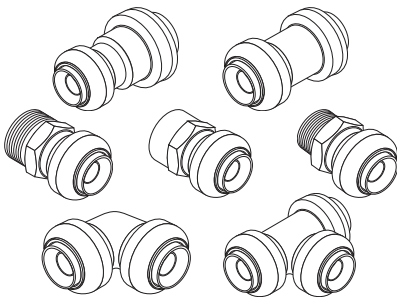

Push-fit Fittings

Push-fit Fittings are designed to simplify pipe installation. The fittings allow you to connect pipe in seconds with relative ease.

- Instant push-fit connection for increased ease-of-use
- No soldering, clamps, unions or glue required
- Lead-free
- Fit copper tubing and PEX piping and connect in any combination

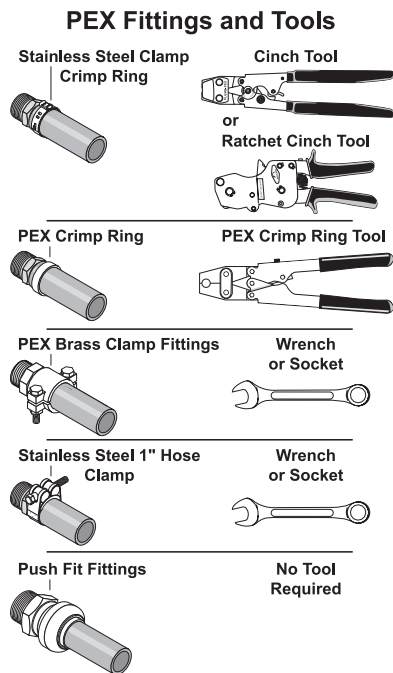

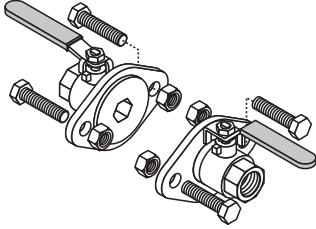

Isolation Flange Kits

An excellent option for "isolating" a circulation pump in the event repair or replacement is necessary. Shut-off valves also aid in purging air from the system.

Shut-off Valves

Shut-off valves must be installed on each hot supply and return water line so each line can be shut off individually for purging air from the system.

- Be sure all valves and fittings are metal. Do NOT use plastic valves or fittings.

Shut-off valves should be installed on both sides of each pump so if it becomes necessary to repair or replace the pump, the pump can be isolated.

Optional Thermostatic Valve

An optional thermostatic valve can be installed on each set of supply and return lines in the system to maintain the outdoor furnace water temperature above 150°F (65°C). Operating the outdoor furnace with the water temperature less than 150°F (65°C) may result in more condensation in the firebox that can lead to corrosion.

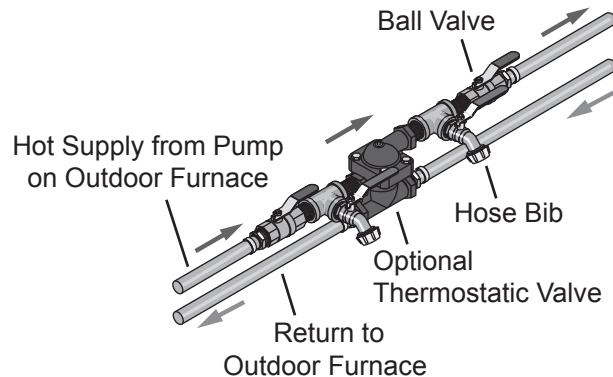

NOTE: Shown with valves added to allow for purging. See Filling Outdoor Furnace and Purging Air illustration.

Thermostatic valves can be purchased through your authorized Central Boiler dealer.

It is recommended to set the water temperature setpoint of the furnace to 185°F (85°C) to decrease the likelihood of the water temperature falling to 150°F (65°C). As a result, the outdoor furnace will operate with a greater efficiency and require less maintenance.

Manual Air Bleeders

Often installed in high points of water lines to "bleed off" air that can become trapped. Trapped air in a water line can cause circulation problems.

Manual Air Bleeders

Manual air bleeders may be installed in the high points of the water lines where air may get trapped and cause circulation problems. Water can be pumped to levels higher than the outdoor furnace as long as the pump is pushing the water to the higher level, all air is purged from the system, and there are no air leaks in the system. If any auto float vents are present in the system, they must be capped off tightly to prevent air from entering the system.

⚠ WARNING

The outdoor furnace vent cap must fit loosely on the vent opening. Do not force the cap down or try to seal it tightly onto the vent pipe. Do not extend or restrict the vent pipe or opening. DO NOT ALLOW THE OUTDOOR FURNACE TO BE PRESSURIZED.

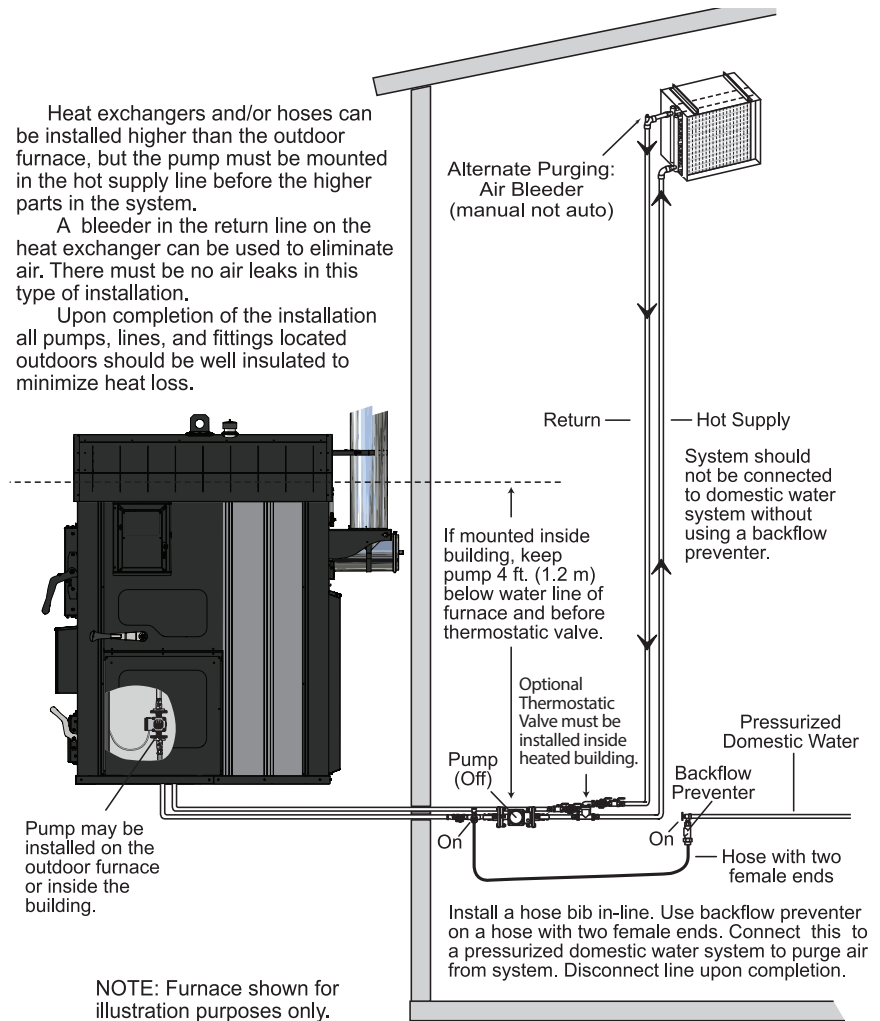

NOTE: See the Hydronic Component Selection Guide for more detailed information.

CONNECTING TO EXISTING SYSTEMS

Remember, your outdoor furnace is not intended to be the only source of heat. In the event of a prolonged power failure, a generator may be used to prevent lines from freezing. Should the outdoor furnace be left unattended, run out of fuel or require service, an alternate heating source in the building being heated should be in place to prevent damage caused by freezing.

Water Heater

Push-fit Fittings Water Heater Kit

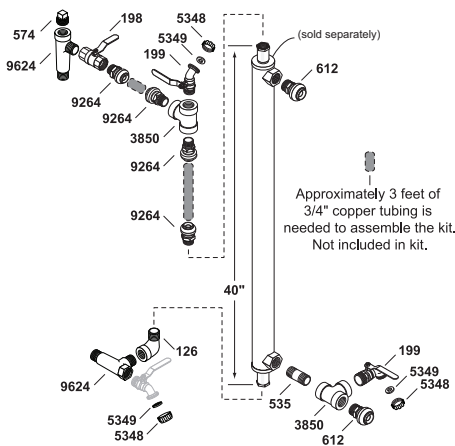

Many owners install a water-to-water heat exchanger on their domestic water heater for even more energy savings. The Push-fit Fittings Water Heater Kit (p/n 9263) makes installation quick and easy.

Water-to-water heat exchanger is sold separately.

⚠ WARNING

DO NOT disable or remove any safety reliefs or controls. Turn off the power to the water heater before installation.

When installing a domestic hot water heat exchanger, the hot supply line from the outdoor furnace should be plumbed first to the water heater heat exchanger and then to the balance of the heating system.

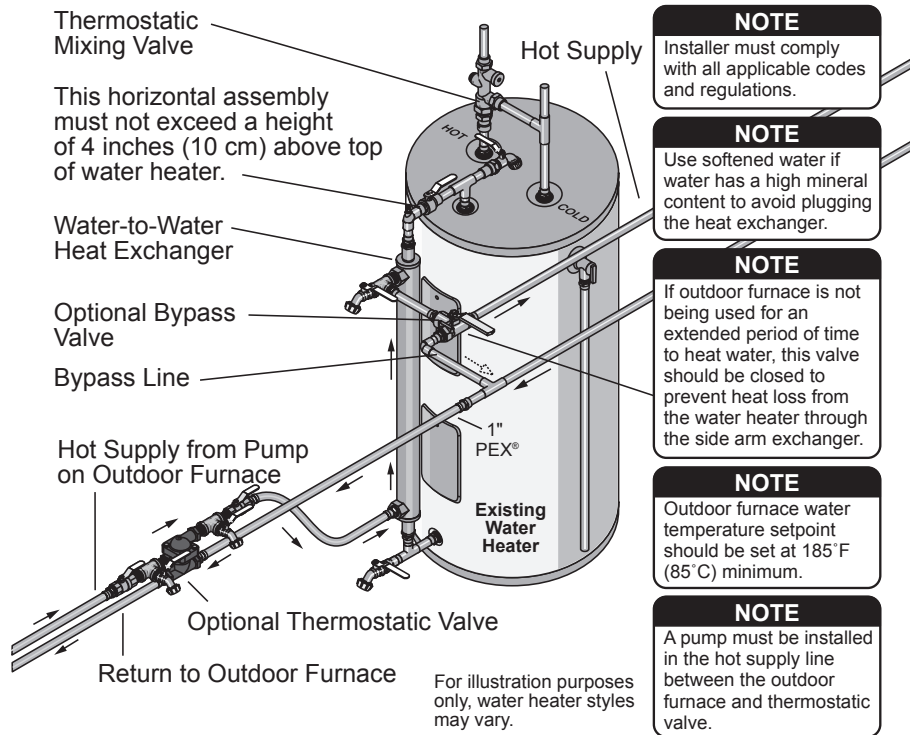

A manual 3-way valve may be installed so that during the non-heating season, the water heater may be operated without operating the entire heating system. A tempering valve (or thermostatic mixing valve) is to be installed in the hot water outlet from the water heater. Install a tee in a fitting on the top of the water heater for the hot water heat exchanger.

NOTE: If the water heater has been in service, flush the water heater prior to installing the hot water heat exchanger. Anode rod residue or other sediments in the water heater may plug the heat exchanger.

⚠ CAUTION

Some gas water heaters are equipped with a high water temperature probe that is connected to the gas valve. When the water temperature exceeds the high limit, the gas valve enters a non-resettable lock out condition. This requires replacement of the entire valve. The installer must determine if this type of valve is present before installation of a water-to-water heat exchanger.

Costly maintenance may be incurred if steps are not taken during installation to eliminate the possibility of the water temperature in the water heater exceeding the high limit.

Domestic Hot Water Flat Plate

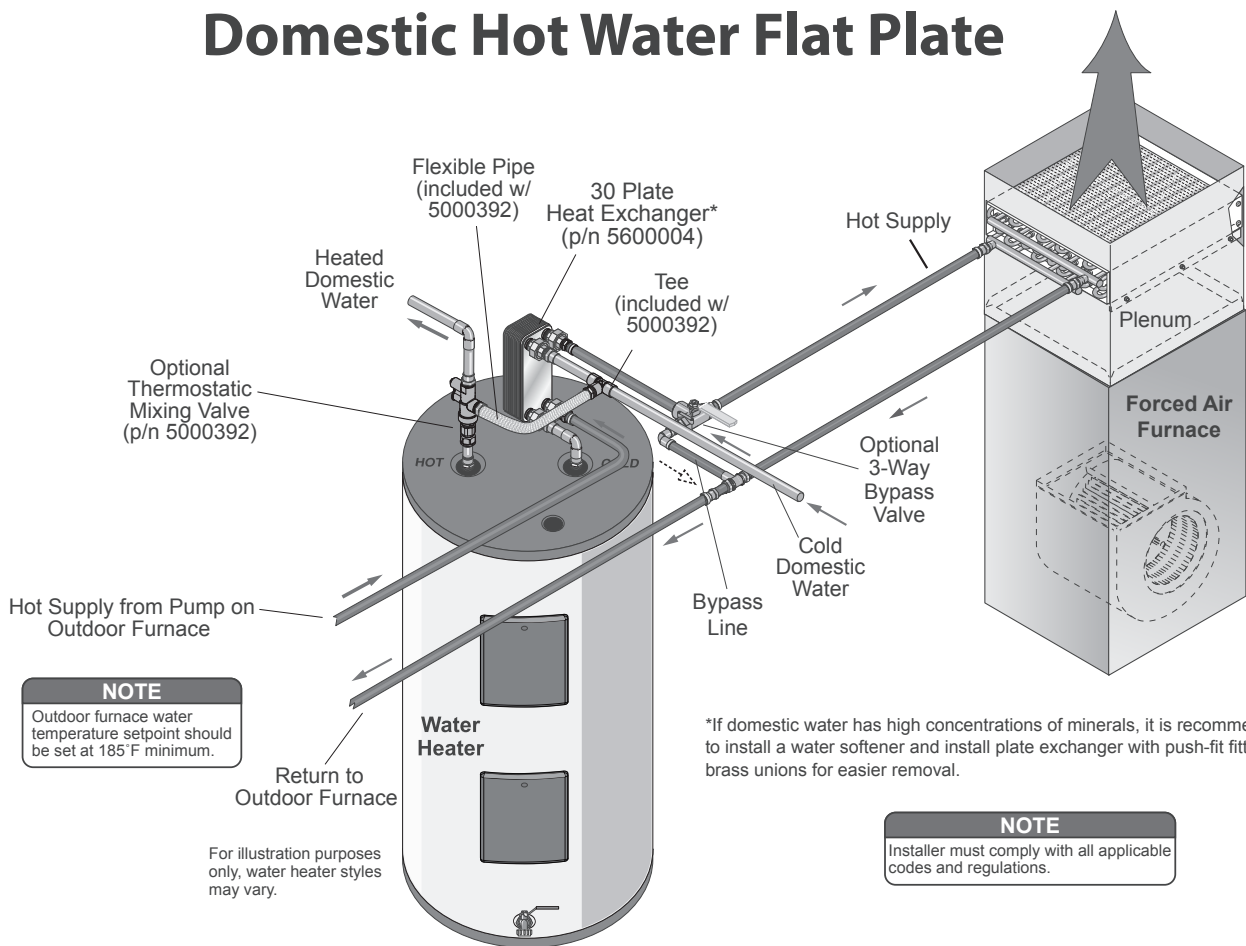

NOTE
Outdoor furnace water temperature setpoint should be set at 185 F minimum.

For illustration purposes only, water heater styles may vary.

*If domestic water has high concentrations of minerals, it is recommended to install a water softener and install plate exchanger with push-fit fittings or brass unions for easier removal.

NOTE
Installer must comply with all applicable codes and regulations.

Existing Forced Air Installations

When the outdoor furnace is installed in conjunction with an existing forced air system, a water-to-air heat exchanger is mounted in the plenum or duct work of the existing furnace. Heated water from the outdoor furnace either continuously flows through the water-to-air heat exchanger or is diverted through a 3-way zone valve. When the thermostat senses the need for heat, the fan on the existing furnace forces air through the heat exchanger, transferring heat throughout the existing ductwork.

Water Flow

For a single building water-to-air heat exchanger system with a domestic water heater, the direction of water flow must go from the hot outlet on the outdoor furnace to the lower side fitting of the domestic water heater exchanger, to the lower fitting of the heat exchanger in the plenum of the existing furnace, and then to the return port of the outdoor furnace.

NOTE: Some systems may have different flow patterns.

Items of Note in Forced Air Installations

- Plenums installed to the furnace must be constructed of metal in accordance with NFPA 90B, 2-1.3.
- If an air conditioning coil is located in the plenum, the heat exchanger should be mounted between the fan and the air conditioning coil so the heat exchanger will not freeze when the air conditioner is being used.
- The heat exchanger **should not** be installed in the cold-air return of the existing forced air furnace because components of the existing furnace could overheat.
- The heat exchanger may be mounted either horizontally or vertically with the outlets on the side.

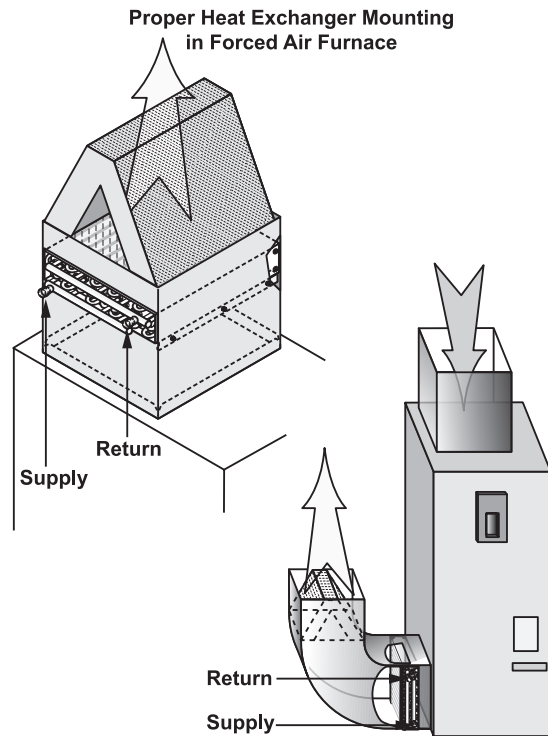

- In all applications, the heat exchanger must be mounted level from front to back, with the outlets on the side. If the outlets are positioned upward or if the exchanger is not level, an air lock can restrict the water circulation and reduce the amount of heat transfer.
- The **lower fitting is the inlet/hot supply** from the outdoor furnace and the **top fitting is the outlet/return** back to the outdoor furnace.
- It is best to install a heat exchanger that fits the plenum.
- If the plenum is larger than the heat exchanger, it should be mounted in the center **without gaps** on the sides that would allow air to flow around the heat exchanger. All air must be directed through the face of the exchanger. Air flow deflectors need to be installed in the plenum on the outlet side of the heat exchanger if air flow is funneled into the heat exchanger.
- Be sure to consider the airflow through the ductwork so air circulation is not blocked off to parts of the building.

- Adding a heat exchanger coil in the hot air plenum or ductwork of the existing furnace may decrease the air flow in the system. The existing heat emitter(s) (gas or electric) should be operated before adding the heat exchanger.
- The air temperature rise should be measured with the heat emitter(s) running for an adequate amount of time to get a stabilized temperature reading. The heat exchanger can then be installed in the system. The existing heat emitter(s) should be operated again and the air flow should be adjusted to maintain the same temperature reading. The air flow may have to be increased to accomplish this.
- On a belt-drive system, the blower pulley and/or motor pulley may be changed; however, the electrical current flowing through the motor must not be changed to exceed the nameplate rating. A larger blower motor may be used. On a direct-drive system, in most cases the blower motor will not need to be replaced; however, the speed of the blower motor may have to be increased.

⚠ CAUTION

When installing the heat exchanger, be sure none of the existing system safety controls are disabled.

NOTE: Any electrical installation should be done by a certified electrician in accordance with all applicable codes.

- Due to the internal circuitry of some thermostats, a snap disc temperature control may have to be installed on the heat exchanger manifold to provide an interlock for the air conditioner. This prevents the air conditioner from operating when the water temperature is higher than 140°F (60°C).

Installing Thermostatic Controls for Forced-Air System

There are several methods for installing thermostatic controls for this type of installation.

If the forced air furnace has connections for control of the blower from a thermostat or switch, the simplest method is to add a second 24-volt thermostat. Wire the thermostat to the forced air furnace so that upon a call for heat, the thermostat closes the connection between power (usually 'R' or red) and the fan terminal (usually 'G' or green). By setting the new thermostat to the desired room temperature, it will control when the blower operates, drawing heat from the outdoor furnace. The existing thermostat should be set a few degrees below the new thermostat. This setting will be the temperature at which the existing forced air heating system will operate if the outdoor furnace is out of fuel. Refer to the following diagram for one possible arrangement.

Wiring Diagram for Additional Thermostat (Forced Air Application)

Connect a wire from "R" on your existing thermostat to "R" on the additional thermostat then connect a wire from "G" on your existing thermostat to "W" on the additional thermostat.

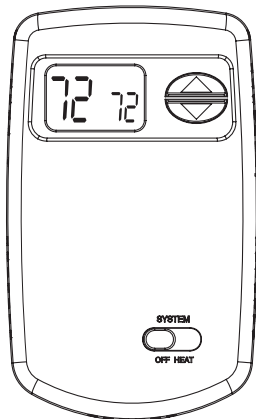

Additional Thermostat (Heat Only)

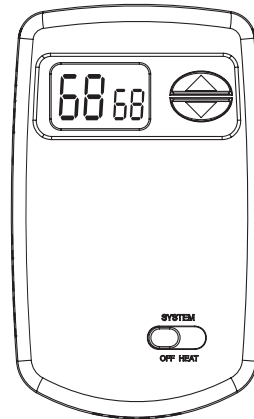

Existing Thermostat (Heat-Cool)

Existing thermostats may vary in style. This is an example illustration only.

NOTE
In order for this system to operate properly, a minimum of 3 wires are required on the existing thermostat. The "G" terminal on the existing thermostat must be connected to the furnace fan relay.

NOTE
The additional thermostat is set to a higher temperature to allow the blower fan to run without running the furnace.

NOTE
This is one of several variations. If air conditioning is present, a temperature control should be installed on the heat exchanger manifold to provide an interlock for the air conditioner. This prevents the air conditioner from operating when the water temperature is higher than 140°F.

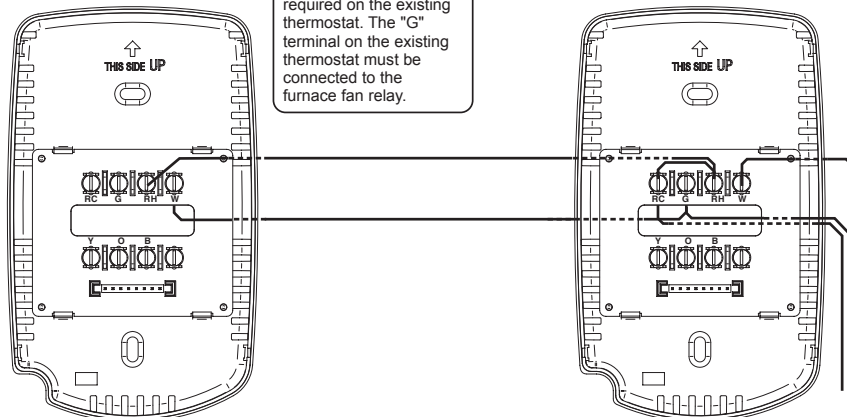

An alternative method is to install a line voltage thermostat to control the blower on the forced air furnace. In this installation, a 120-volt line is run from the thermostat to the forced air furnace. One wire is connected to the hot (line feed) and the other wire is connected to the forced air furnace blower wire. A low water temperature switch may be installed to shut off the blower if the temperature of the water is too low. The switch is connected in series to the wire coming from the line voltage thermostat and must be installed so that it does not affect the forced air system thermostat.

NOTE: If the low water temperature switch is not installed, the fan will run continuously even when the outdoor furnace is out of fuel. This will keep the water in the outdoor furnace approximately the same temperature as the air in the house (to prevent the water in the outdoor furnace from freezing).

Single Thermostat (with Aquastat)

Existing 24V Thermostat



Disconnect wire from “W” terminal on forced air furnace and connect it to the “R” terminal on aquastat. Connect a wire to “W” terminal on forced air furnace and to the “B” terminal on aquastat. Connect a wire to “G” terminal on forced furnace and to the “W” terminal on aquastat.

NOTE
Any electrical installation should be done by a qualified installer in accordance with applicable codes.

NOTE
Aquastat will be on supply line to the heat exchanger. Control will be sent to the “G” when the line is above set temperature and the fan will turn on with a call for heat. When the line is below set temperature, the control will be sent to “W” and the furnace will fire as it normally did.

NOTE
This is one of several possible variations using an existing thermostat. If air conditioning is present, the air conditioner breaker may have to be shut off or a relay installed.

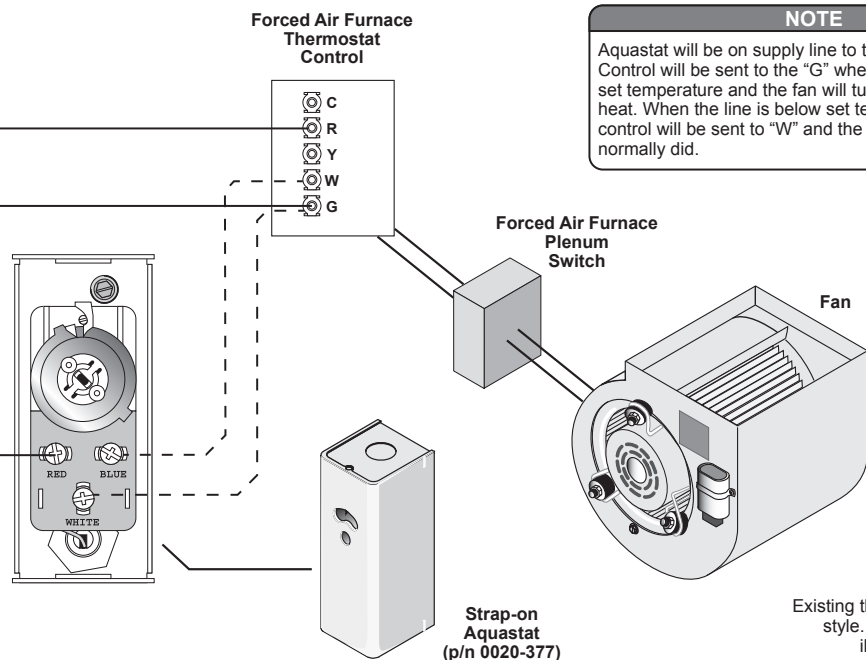

Existing thermostats may vary in style. This is an example illustration only.

Water-to-Air Heat Exchanger and Water Heater System

NOTE: A certified electrician must perform the electrical installation.

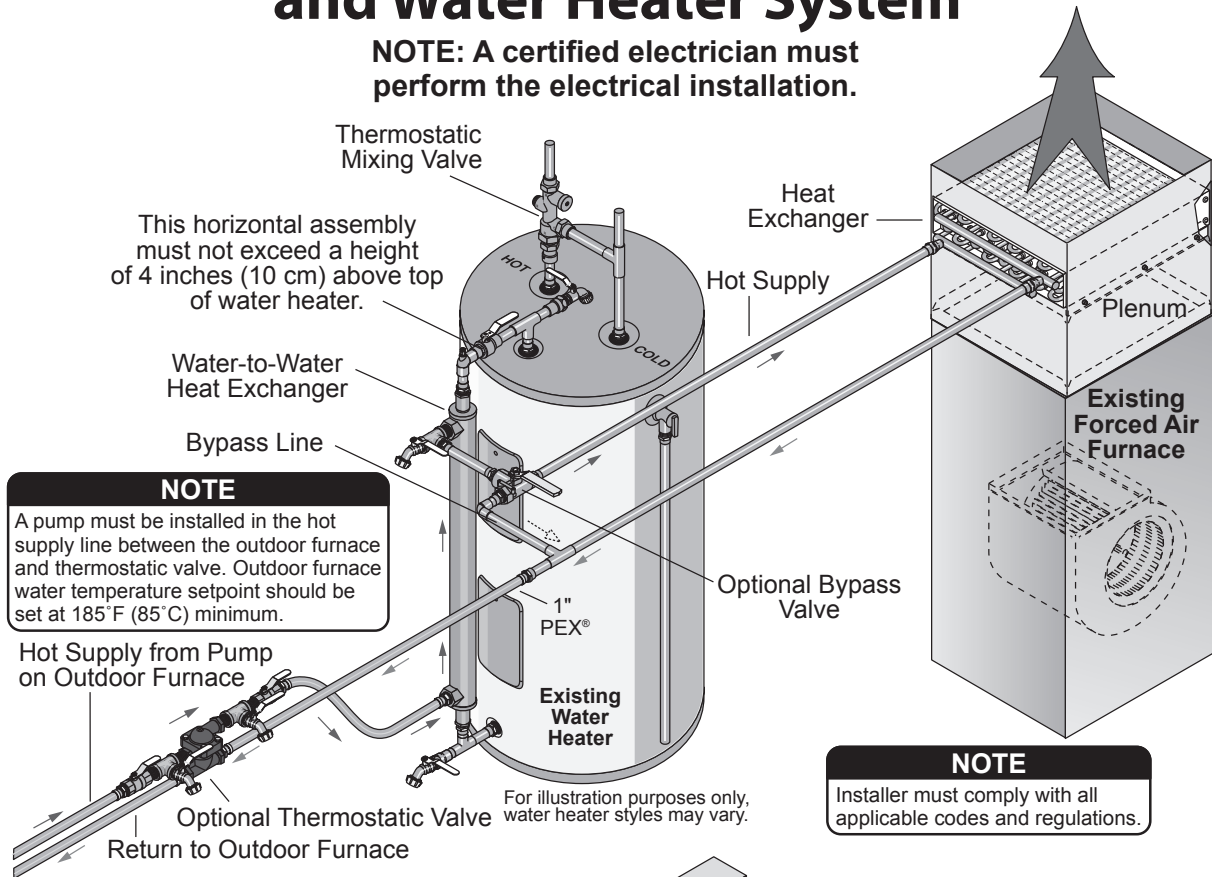

NOTE
A pump must be installed in the hot supply line between the outdoor furnace and thermostatic valve. Outdoor furnace water temperature setpoint should be set at 185°F (85°C) minimum.

NOTE
Installer must comply with all applicable codes and regulations.

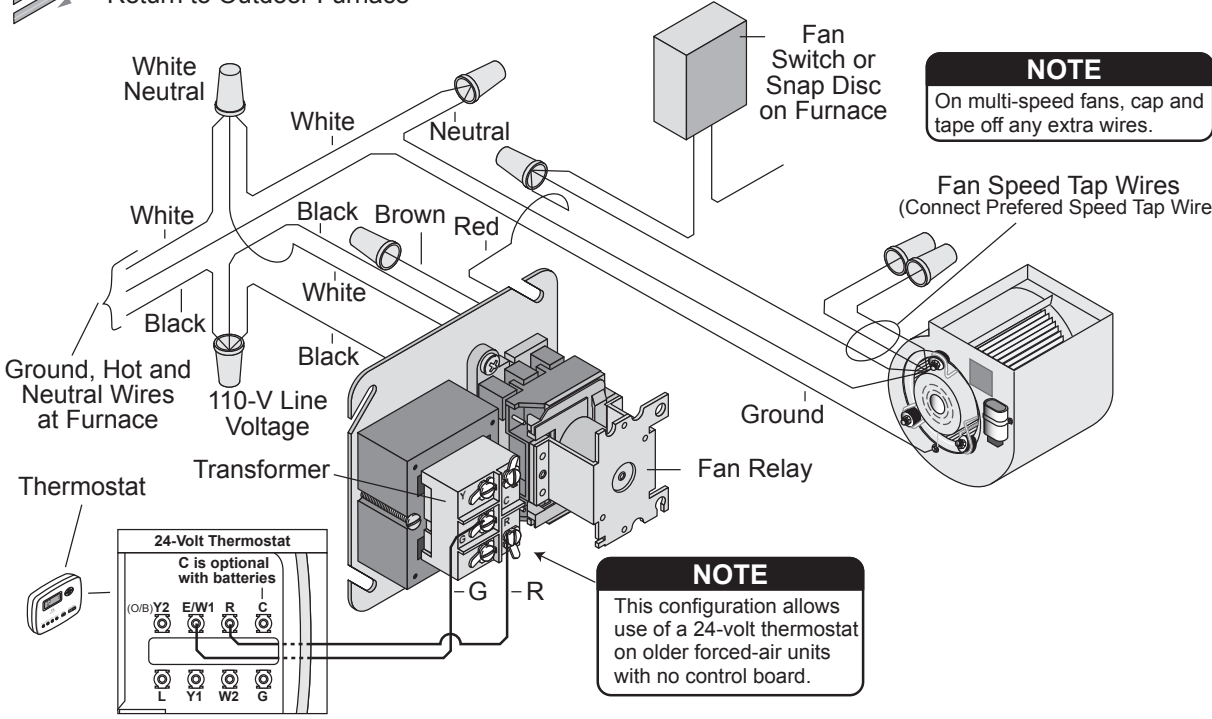

NOTE
On multi-speed fans, cap and tape off any extra wires.

NOTE
This configuration allows use of a 24-volt thermostat on older forced-air units with no control board.

For illustration purposes only.

Forced Air System and Water Heater Heat Exchanger Components

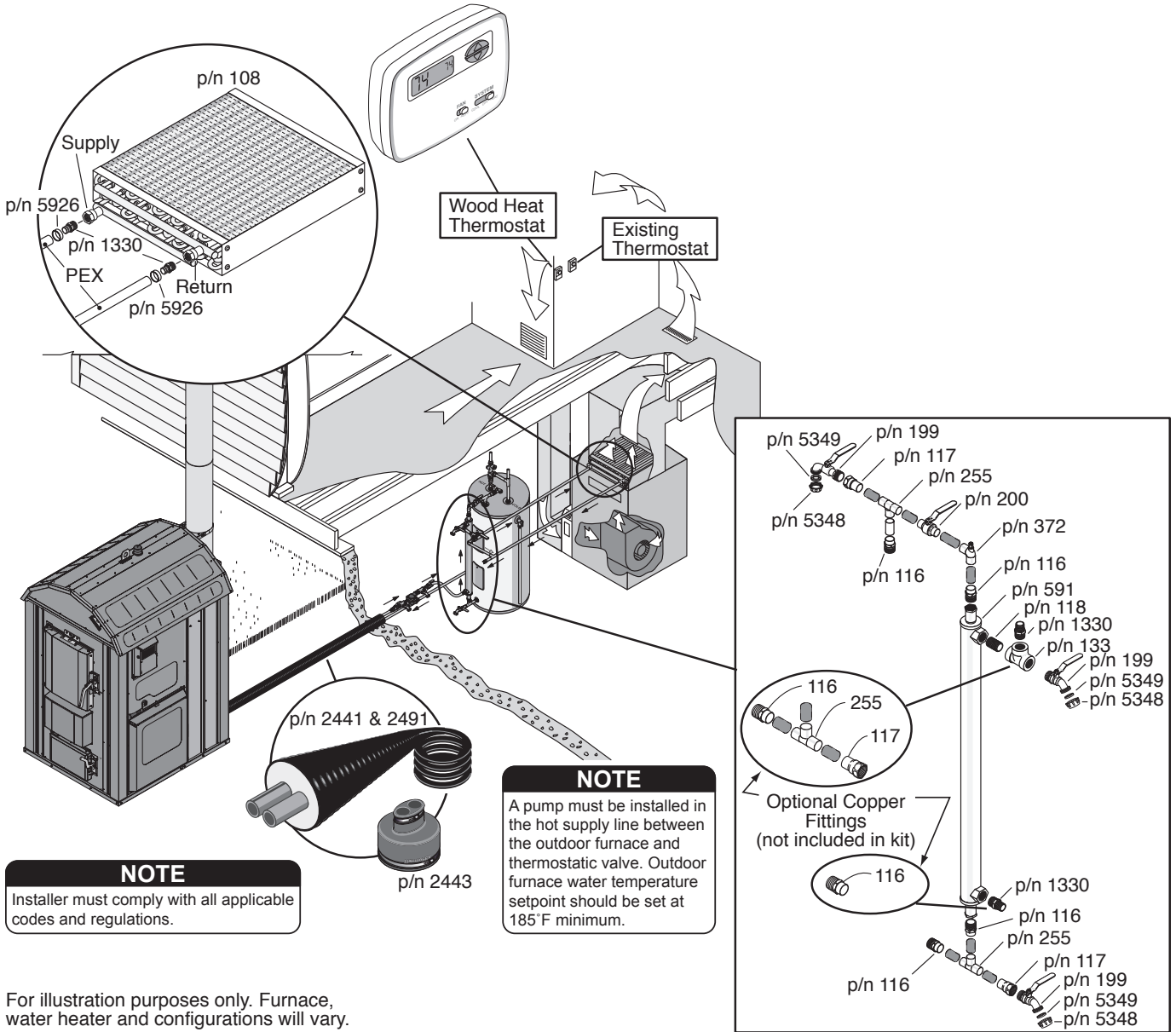

Heating Multiple Zones

A single pump and manifold may be used to heat more than one zone as long as the return water can be maintained above 150°F (66°C). If the return water temperature can not be maintained above 150°F (66°C), then a separate pump should be used for each zone. A thermostatic valve must be installed to ensure that the water temperature in the outdoor furnace is maintained above 150°F (66°C).

Some furnaces have more than one set of supply and return ports. This can be an option for mounting pumps on the outdoor furnace for more than one zone or building, without the need for manifolds.

NOTE: Pump(s) may be installed on the outdoor furnace or inside the building.

NOTE: If a Taco 014 pump is used, the pump should be mounted at the base of the outdoor furnace and a 1-1/4" supply line to the pump should be used to ensure adequate supply feed to the pump. See the Hydronic Component Selection Guide for more detailed information.

NOTE: If the outdoor furnace is unable to maintain a water temperature of 150°F (66°C) or higher, inspect the thermostatic valve and replace if necessary.

NOTE: A properly-sized backup furnace or boiler should be configured to provide heat if the outdoor furnace is out of wood or the heat load exceeds the capacity of the outdoor furnace.

Heat for Multi-Buildings

For illustration purposes only. Furnace, water heater and configurations will vary.

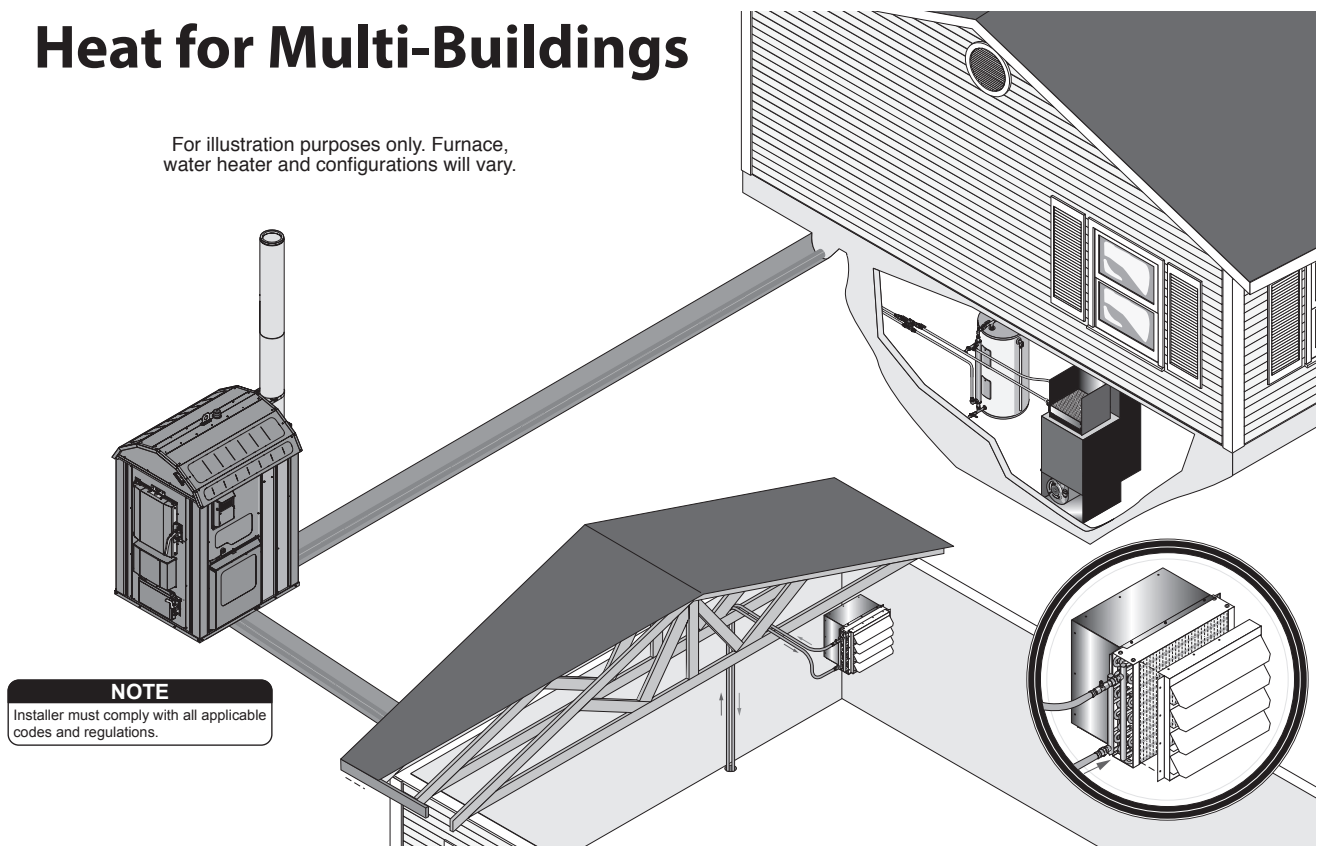

NOTE
Installer must comply with all applicable codes and regulations.

Hydronic Systems

There are several different kinds of existing hydronic systems that the outdoor furnace can be connected to, and other systems that may require modification or addition of components. Read through this section thoroughly before proceeding to determine how to connect to your system.

- As a general rule in all hydronic systems, it is recommended to locate the circulation pump in the hot supply line, not the return line.

Filters

A Y-strainer or filter may be installed at the outlet side of the pump to remove foreign particles which may be present in the water. Always install Y-strainers with the cleanout in the lowest position.

Evaluate Your Existing System Before Installation

Evaluate the existing hot water heating system before starting the installation. If the existing hot water heating system has been unable to maintain the temperatures in the home at any time during cold weather before installing the outdoor furnace, then the hot water heating system is not adequate. More baseboard or other type of heat exchanger must be added.

If a water-to-water heat exchanger is to be used with an existing heating system, the existing heating system must be able to adequately heat the building with a water temperature of approximately 165°F (74°C). Some existing finned tube baseboard hot water heating systems are designed to operate with water temperatures up to 220°F (104°C) or higher.

If the existing heating system is marginal or designed to operate with water temperatures above 165°F (74°C), there are alternative installation procedures that will make the existing system work very well with the outdoor furnace. These include:

1. Add more finned tube water baseboard heaters or panel radiators.
2. A water-to-air heat exchanger with a thermostatically controlled fan can be installed in the lower part of the building being heated. This can increase the amount of heat added to the building, helping to maintain a constant temperature. This heat exchanger can be added in the return line of the system after the water-to-water heat exchanger.
3. An additional radiant heating circuit can be added to heat areas that require additional heat.

Water-to-Water Shell & Tube Exchanger with Existing Boiler

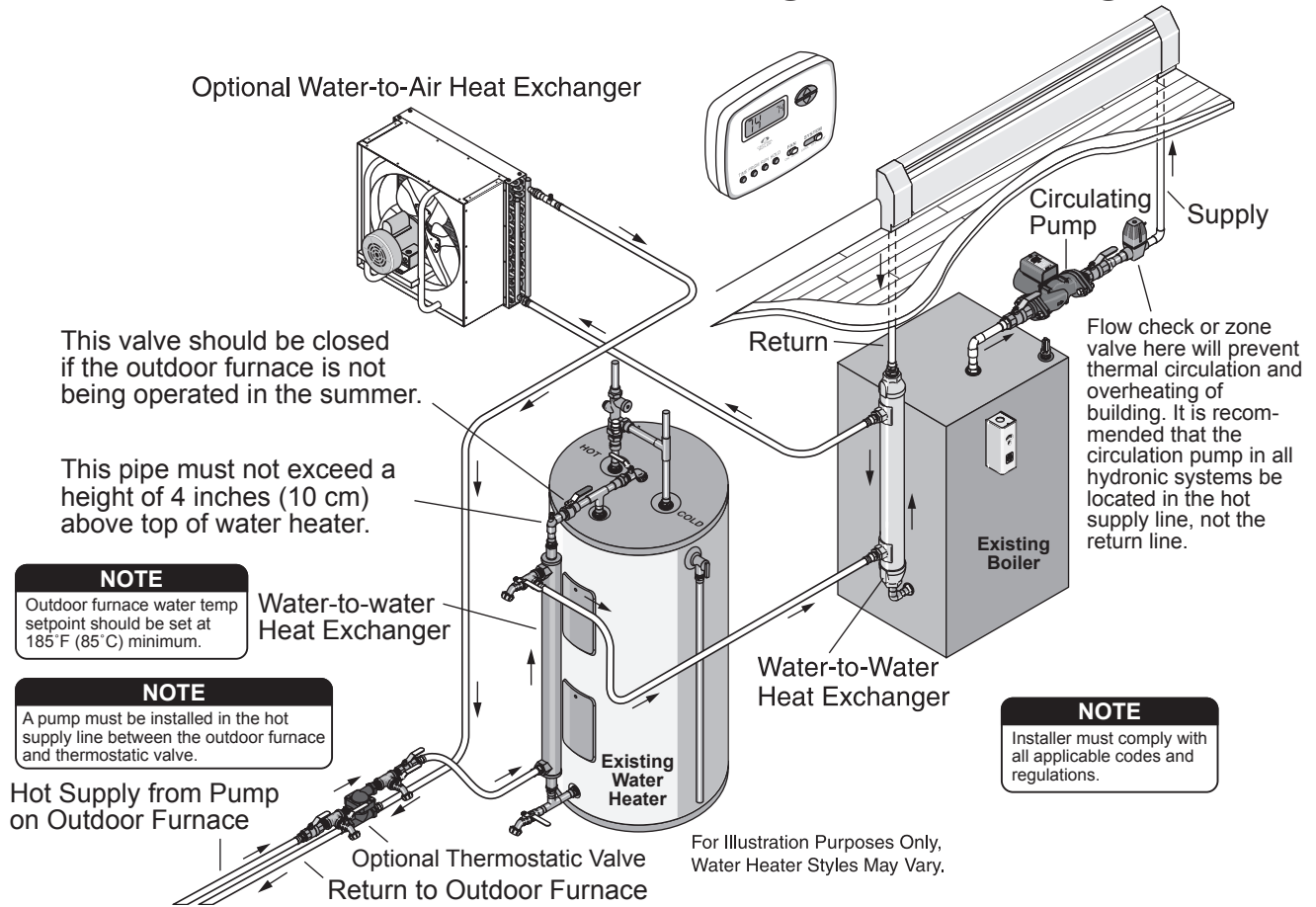

Connecting to an Existing Boiler System - Pressurized

To keep the existing system pressurized, a plate exchanger or shell & tube water-to-water heat exchanger installed in the return line of the existing system may be used. The water from the existing system passes through the heat exchanger when the thermostat calls for heat. The water from the outdoor furnace circulates through the other side of the heat exchanger continuously.

It may be necessary to lower the water temperature at which the burner in the existing boiler starts to a setting that prevents the burner in the existing boiler from cycling on when the outdoor furnace is heating the home. Another option is to install a thermostatically controlled interlock switch that prevents the burner in the existing boiler from operating when the water temperature in the outdoor furnace is above 150°F (66°C).

Water-to-water heat exchangers will produce transfer temperatures approximately 20°F (11°C) less than the outdoor furnace water temperature; therefore if the outdoor furnace water temperature is 185°F (85°C), it will produce approximately 165°F (74°C) of water temperature transfer. The temperature controller on the outdoor furnace may be adjusted to allow the outdoor furnace to reach water temperatures up to 195°F (91°C). Each system will vary in water temperature transfer depending upon the heat load of the existing heating system.

The addition of a wraparound pump with a water-to-water heat exchanger may increase heat transfer by allowing circulation continuously through the existing boiler and heat exchanger. This will maintain the maximum temperature in the heat exchanger for heat transfer to the existing boiler. Note the water flows in opposite directions through the heat exchanger.

With this type of installation, the exchange temperature may be more than 165°F (74°C) and may eliminate the need for additional baseboard heaters, panel radiators or heat exchangers.

When installing water-to-water heat exchangers, be sure to flush any rust particles or sediments out of the existing boiler and install a Y-strainer. Also be sure to add MolyArmor 350 Corrosion Inhibitor as required.

A Taco 007 pump can be used as a wraparound pump when a plate exchanger is installed. A Taco 009 pump should be used when a shell and tube heat exchanger is installed.

NOTE: See the Hydronic Component Selection Guide for more detailed information.

Existing Boiler - Pressurized (with Wraparound Pump)

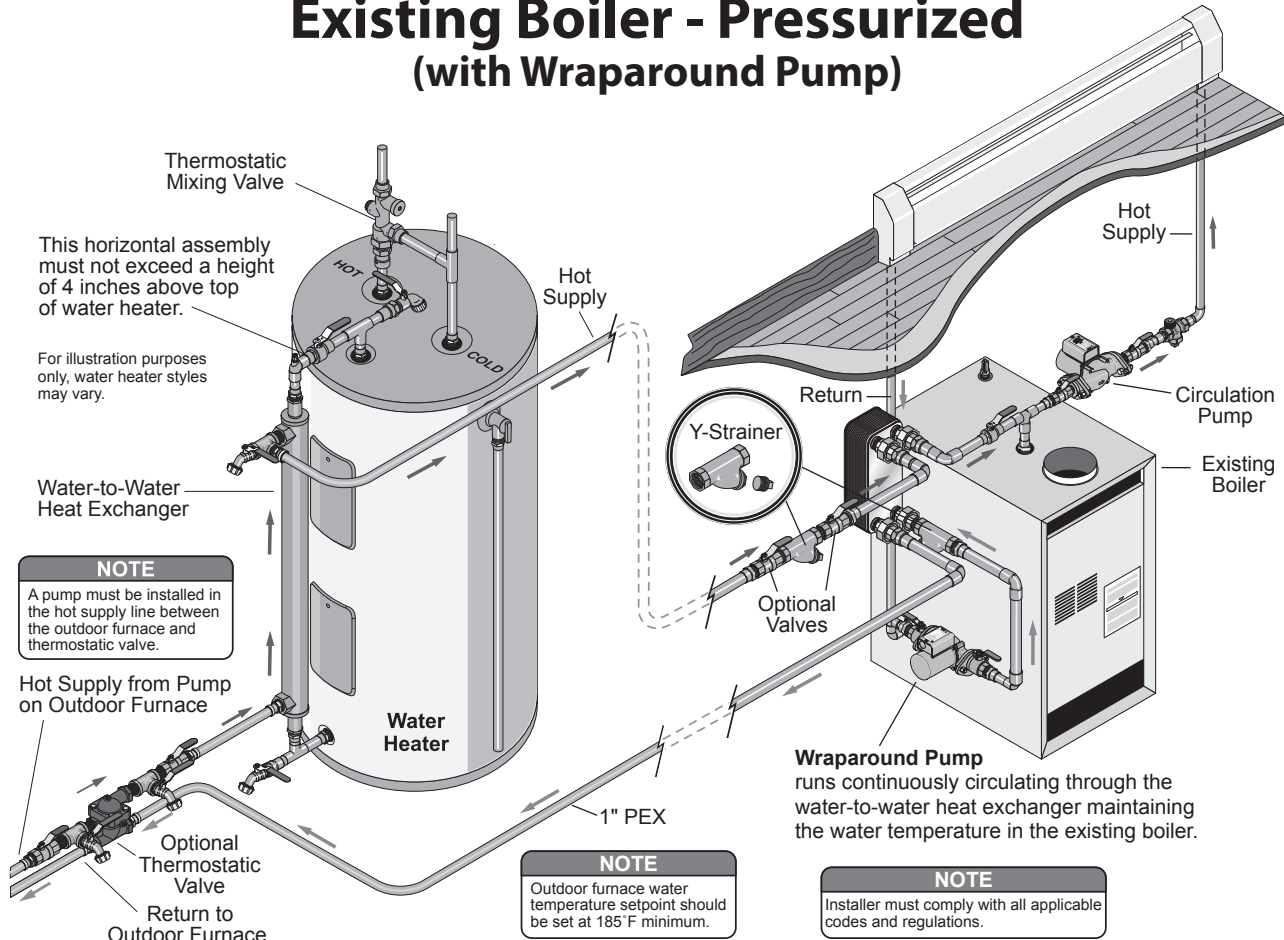

Connecting to an Existing Boiler System - Vented

The outdoor furnace may be connected directly into an existing hot water system, changing it to an atmospheric vented system.

NOTE: Any changes in the existing boiler and/or system should be done by a certified installer in accordance with applicable codes. Be sure the system water is properly maintained with MolyArmor 350 Corrosion Inhibitor (see Water Quality and Maintenance section).

The hot supply line from the outdoor furnace can be connected into the top of the existing boiler and returned to the outdoor furnace from the bottom of the boiler. Use one pump to continuously circulate the water from the outdoor furnace through the existing boiler and back to the outdoor furnace.

⚠ CAUTION

The outdoor furnace must NEVER be pressurized. The vent cap must always be loose. Do not extend the vent pipe. The outdoor furnace will be damaged if it is pressurized.

Direct Circulation to Existing Boiler

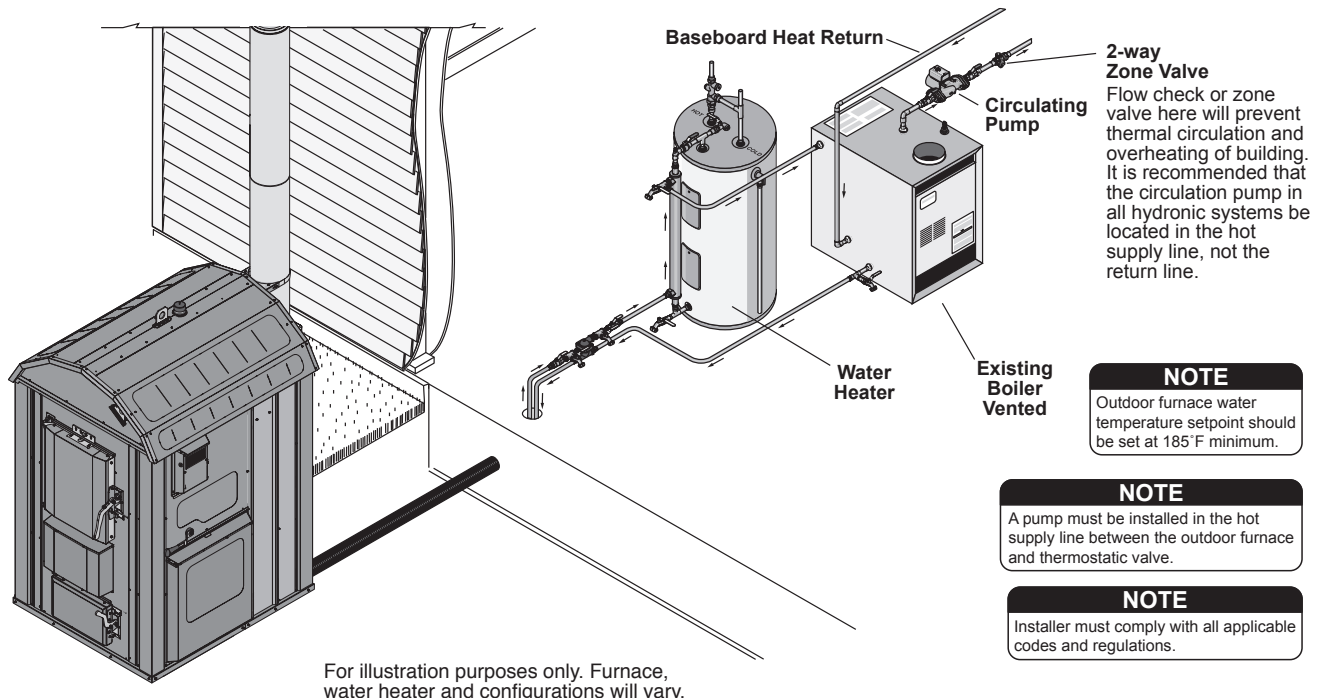

When the existing system is connected to the outdoor furnace as illustrated above, the circulating pump(s) in the existing system must be located in the hot supply line(s), not in the return line(s). A flow check or zone valve will prevent thermal circulation and overheating of the building.

It is very important to eliminate all air and water leaks (valve packings, bleeders, etc.) and purge all air from the existing system.

1. After filling the outdoor furnace and existing system with water (see Finalizing the Installation section in Owner's Manual), purge the air from the indoor system by closing the valves on the outdoor furnace; then pressurize the indoor system with water from the domestic water line.

⚠ CAUTION

Do not apply more pressure to the indoor system than the pressure relief valve on the existing boiler is rated for.

2. Bleed air from the pressurized indoor system; then operate the circulating pump(s) on the indoor system. Perform this procedure twice. If any auto float vents are used in the existing system, they must be capped off tightly after the air bleeding is completed. This eliminates the possibility of allowing air to enter after the system is depressurized.
3. When the indoor system is completely purged of air, close the valve on the water line used to pressurize the indoor system. If any air is trapped in the system, it can reduce water flow. This will prevent the system from heating properly.
4. Open valves on the outdoor furnace, turn on the pump and proceed to start the fire in the outdoor furnace.

Connecting to Hydronic Baseboard Heaters

Baseboard heaters, as either the main source of heat or as supplements to forced-air or boiler applications, are easily plumbed into the water lines from the outdoor furnace. Following are direct circulation baseboard installation examples.

Dual System (Baseboard / Forced Air)

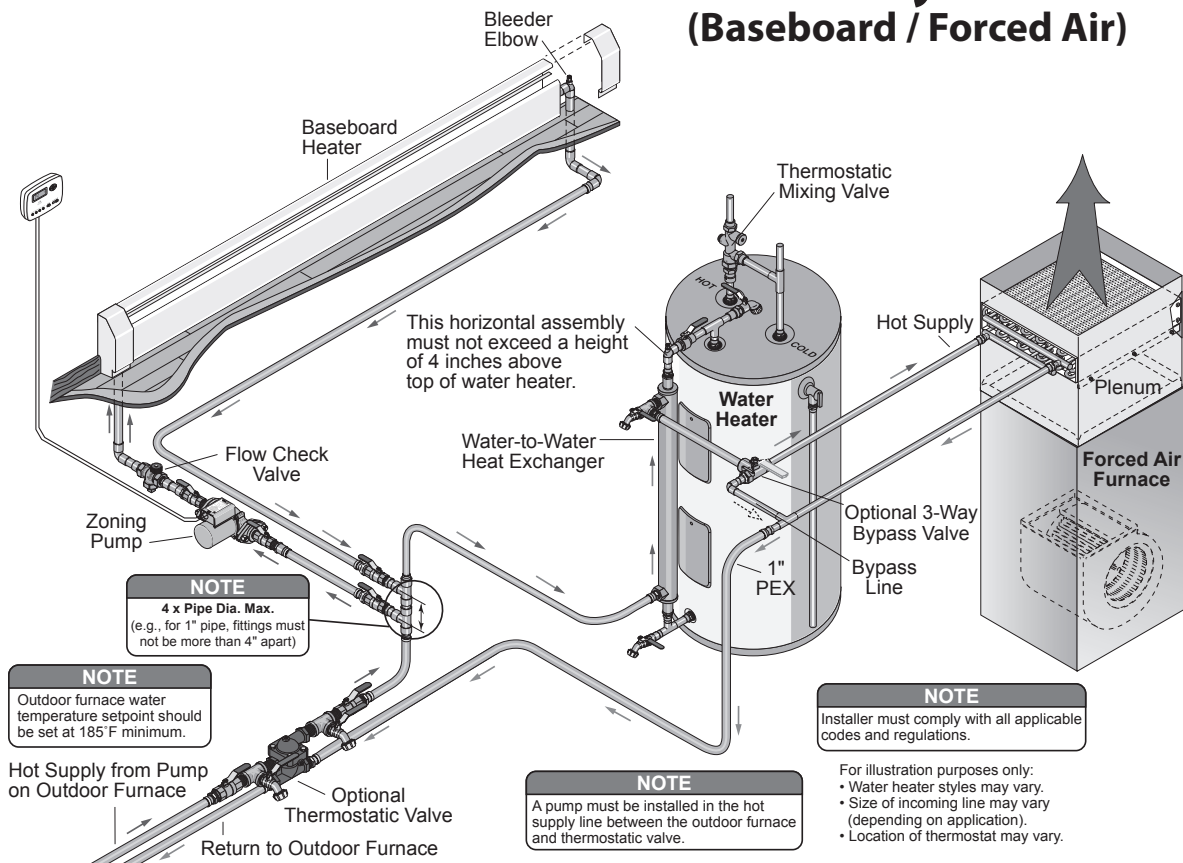

Baseboard System (Three Way Zone Valve Controlled)

NOTE
Outdoor furnace water temperature setpoint should be set at 185°F minimum.

This horizontal assembly must not exceed a height of 4 inches above top of water heater.

NOTE
A pump must be installed in the hot supply line between the outdoor furnace and thermostatic valve.

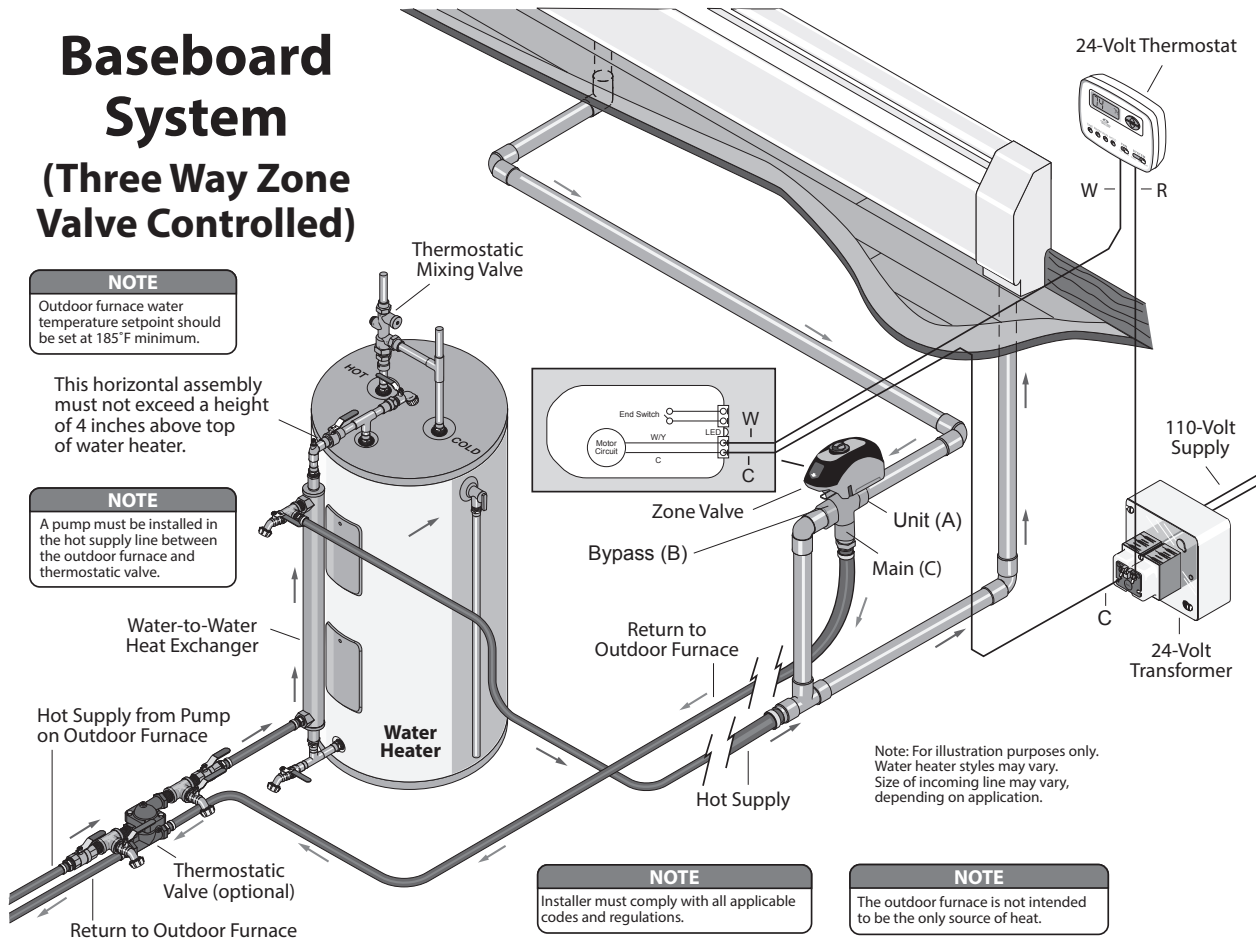

Note: For illustration purposes only. Water heater styles may vary. Size of incoming line may vary, depending on application.

NOTE
Installer must comply with all applicable codes and regulations.

NOTE
The outdoor furnace is not intended to be the only source of heat.

Hydronic Radiant Systems

According to Energy.gov, hydronic systems are the most popular and cost-effective radiant heating systems for heating-dominated climates. Hydronic radiant floor systems pump heated water through tubing laid in a pattern under the floor. It therefore is an excellent choice when either remodeling or building new. Radiant floor heat can also be added to an existing home easily if the floor joists are exposed (as in an unfinished basement).

Tips for Radiant Systems

- Piping may be installed in a wide variety of configurations and locations including, but not limited to, the following: in a concrete slab, within the subfloor system (e.g., Gyp-Crete®), within the floor joist system, within the walls or ceilings
- When installing piping between floor joists (16" or 41 cm on center) run two 1/2" pipes between each joist. Insulate below the piping to prevent excessive heat in the lower level.
- Proper insulation is key to effective radiant heating and controlling large heat demands. Heat from this type of system radiates equally in all directions. As an example, if piping is installed in a slab, the ground below the slab must be dry and well-insulated. If not properly insulated, nearly 50% of the heat will be wasted warming the ground below the slab. Two inches (5 cm) of blueboard insulation is recommended. Two 1" (2.5 cm) layers of blueboard can be used. This allows lapping of the joints in the 4' x 8' (122 x 244 cm) sheets.

NOTE: Do not use beadboard (expanded polystyrene), bubble foil or roll-out foam insulation.

NOTE: A minimum of one inch (2.5 cm) of insulation should be used. Two inches (5 cm) of insulation and vapor barrier below the insulation is recommended.

- Areas with high water tables need to be prepared properly to prevent contact between the ground water and insulation.

- The spacing of each circuit is 12" (30.5 cm) between pipes. The water circulates in opposite directions to provide an even distribution of heat. The mixing valve regulates the temperature of the water circulating through the loops by mixing return water with the hot supply water. In applications where high heat loss is expected, loop spacing may be reduced to 10" (25 cm) or less. If additional information is desired, contact your dealer.

NOTE: The longer the loop length, the lower the flow rate and the lower the heating capacity. Loop lengths greater than 350 feet (107 m) are not recommended.

NOTE: The temperature of the water used in radiant heating should be determined by the installer in accordance with the application.

NOTE: It is not uncommon that it can be very difficult to get a concrete slab up to temperature in late fall or early winter in a new building that is not completely sealed and not well insulated. Once the building is completely sealed and well insulated, bringing the slab up to temperature can still take a considerable amount of time and wood; however, once warm, wood consumption will be reduced if the concrete slab and building are insulated properly .

Radiant Floor Heat (For Slab on Grade or Basement)

NOTE: If the temperature of the concrete slab is below freezing (32°F), there must be adequate antifreeze in the system, or the slab must be pre-heated, before water is circulated through the radiant slab system.

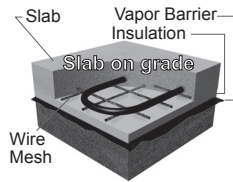

2" Blueboard Styrofoam® is recommended (minimum of 1" Blueboard Styrofoam®).

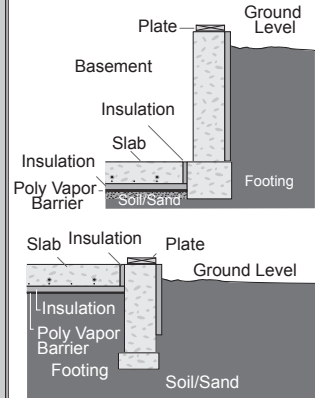
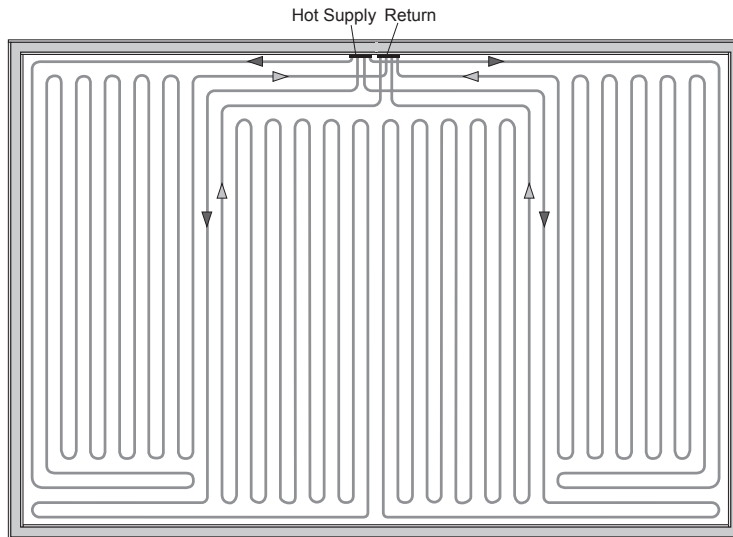

Multi Zone In-Floor

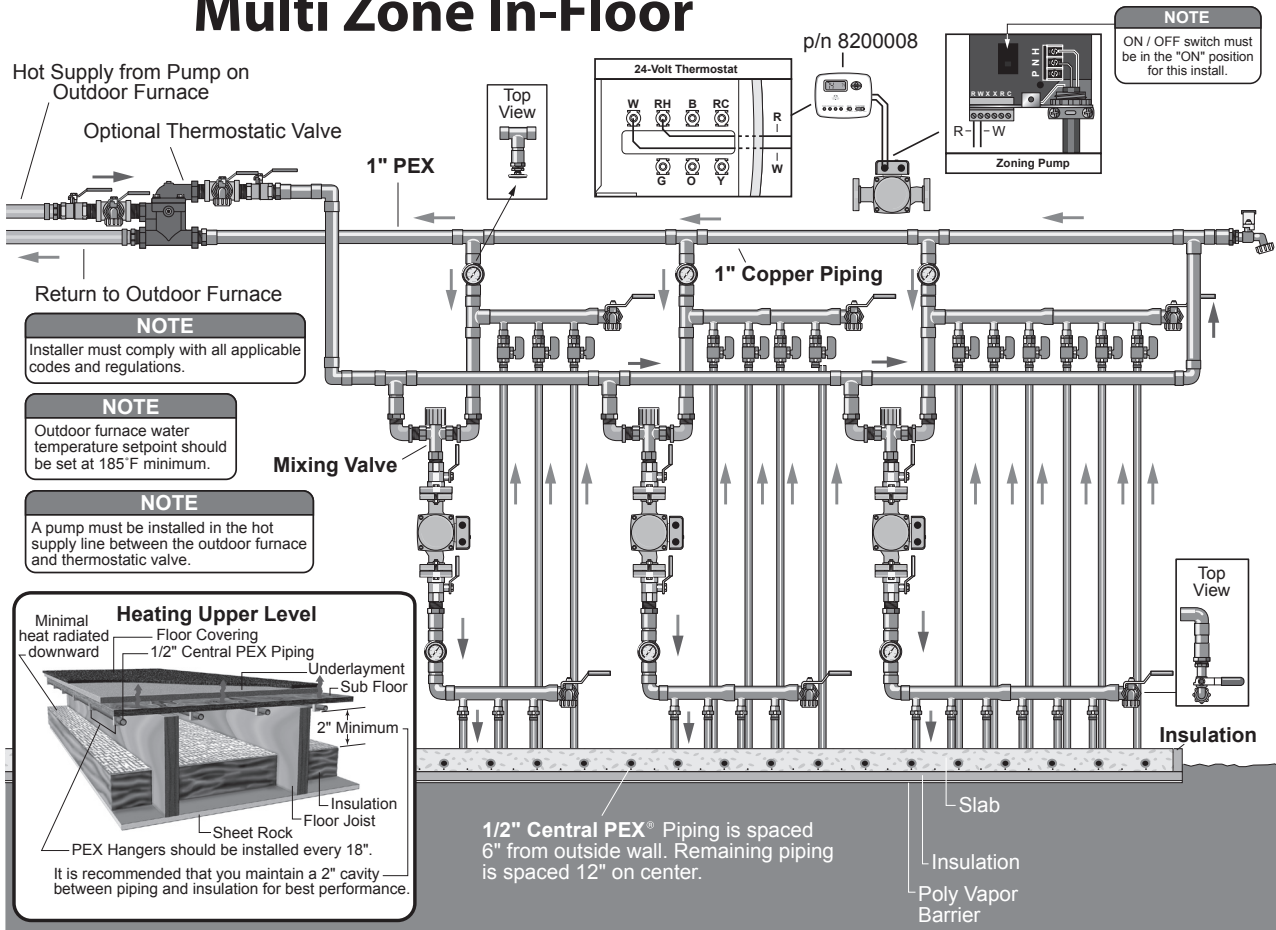

Dual System (In Floor Radiant / Forced Air)

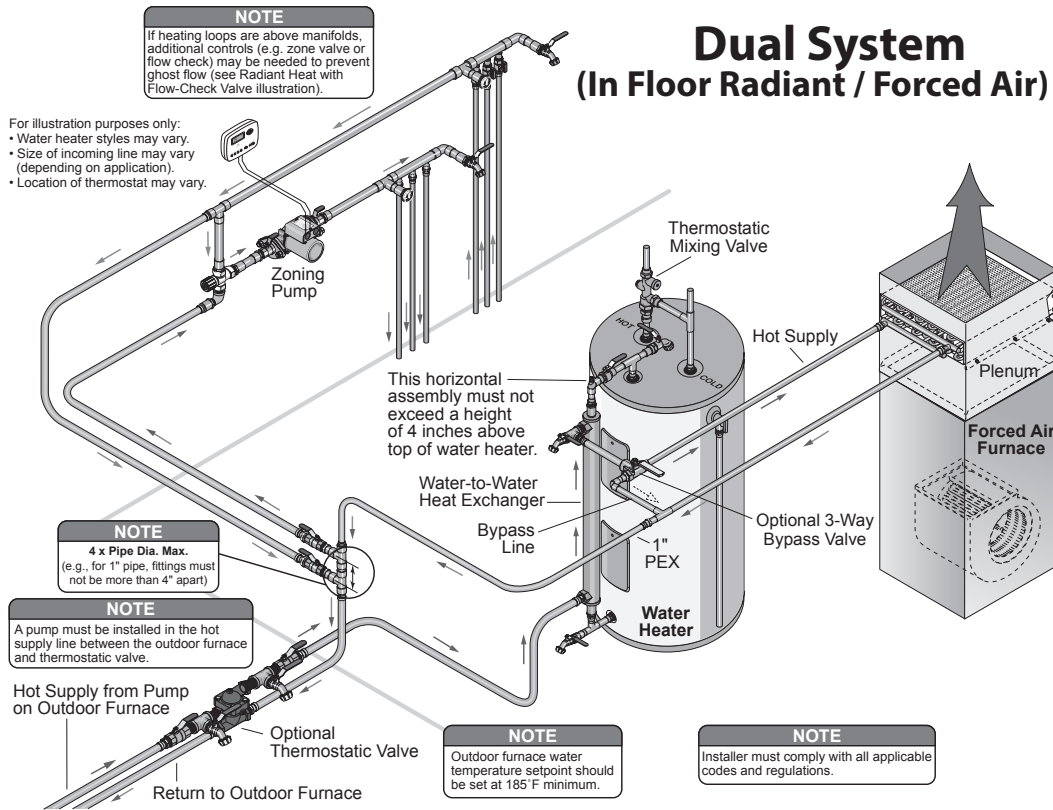

Radiant Heat Single Zone

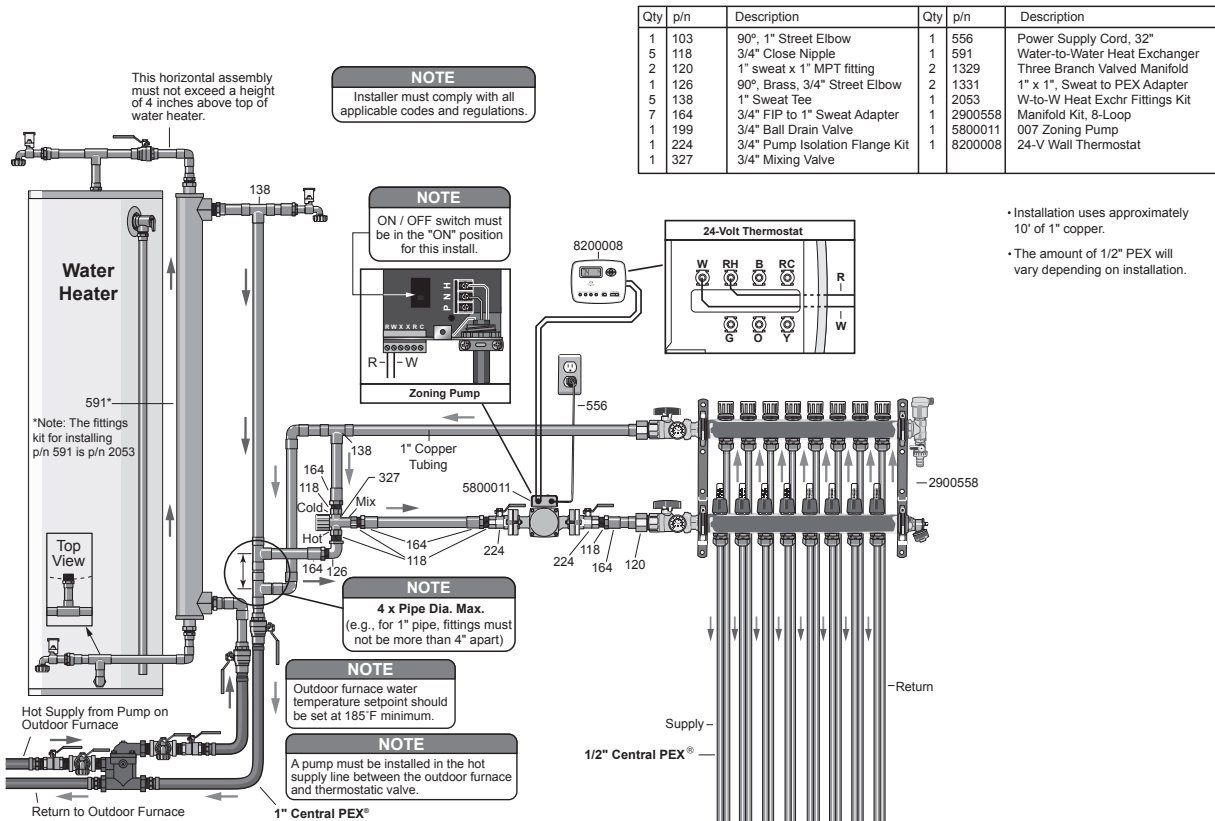

High Volume Water Heating (shown with 1-1/4" components)

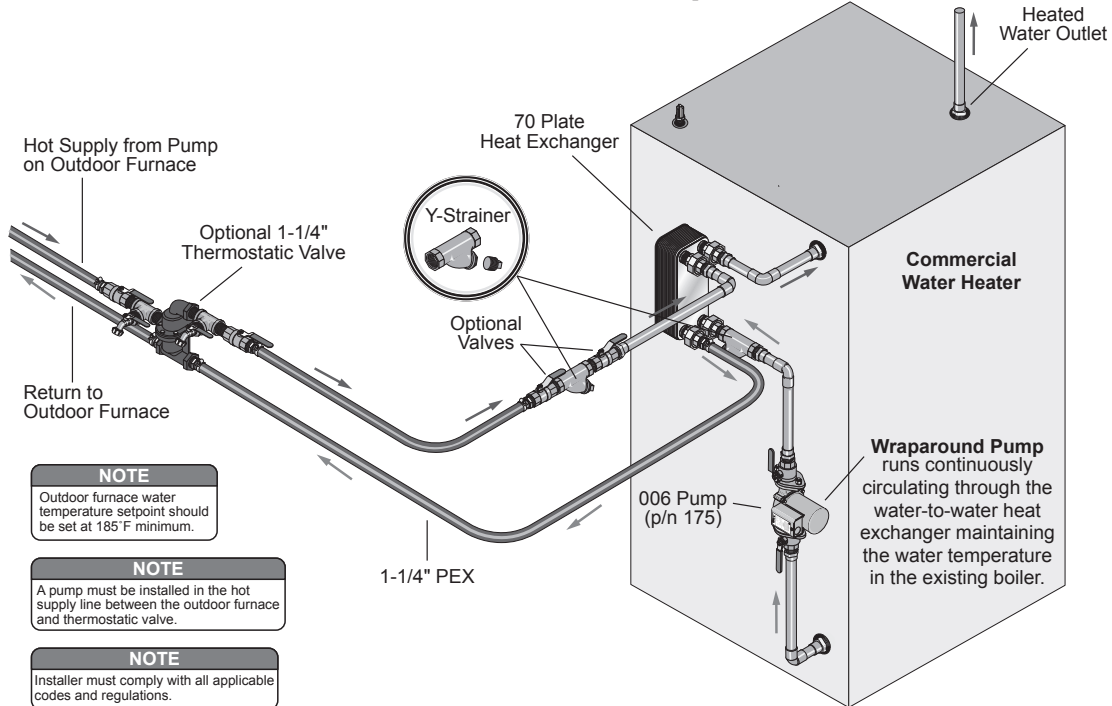

Swimming Pool/ Hot Tub Installation

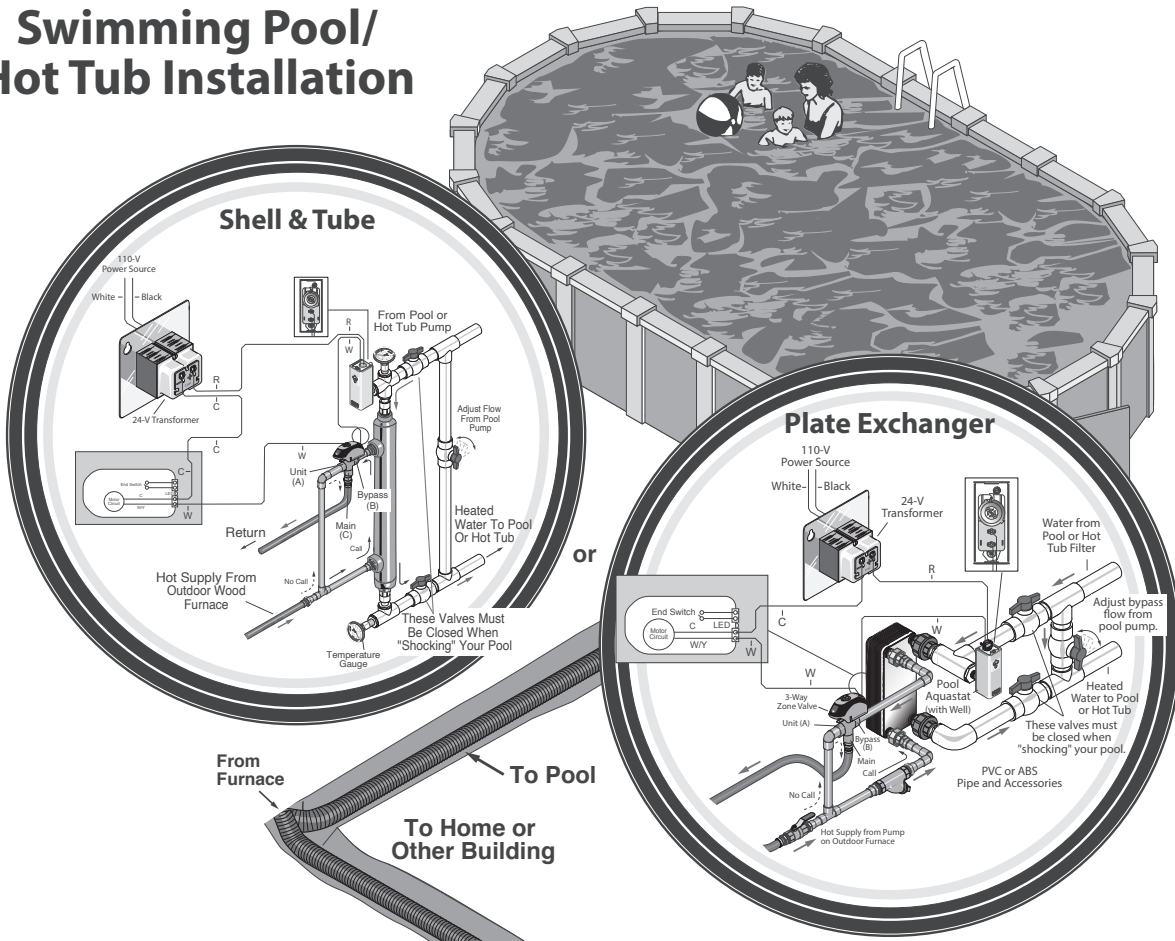

Pool and/or Hot Tub Heating

Valves should be installed so the heat exchanger can be isolated and bypassed when shock-treating or adding chemicals to a pool or hot tub. Incorrect chemical concentrations can cause rapid corrosion to the heat exchanger. Bypassing the heat exchanger is recommended until the pH has stabilized between 7.2 and 7.8.

If the swimming pool or hot tub is salt water treated, the heat exchanger should be a shell and tube type (see Central Boiler Parts Catalog or consult your Central Boiler dealer). See the Hydronic Component Selection Guide for more detailed information.

⚠ CAUTION

Do not install a swimming pool heat exchanger inside a home or building below the level of the pool as a damaged heat exchanger may result in extensive flooding and draining of the pool.

⚠ WARNING

Do not use automotive or ethylene glycol antifreeze in an outdoor furnace connected to a swimming pool heat exchanger as a damaged heat exchanger may cause severe personal injury, death, or substantial property damage.

⚠ CAUTION

Do not operate the outdoor furnace frequently or for extended periods of time with the water temperature below 150°F (65°C) as this will result in more condensation in the firebox that can lead to corrosion.

FINALIZING THE INSTALLATION

Use the steps in this section to complete the installation and fill the outdoor furnace system for the first time, or any time the system has been completely drained and needs to be refilled.

Before you fire the outdoor furnace for the first time, it is very important to perform the following important steps in order.

1. Test Supply Water

Test a sample of the supply water (makeup water) that will be used to fill the outdoor furnace (softened water is recommended). Test strips for testing pH are included in the water test kit which is provided with the outdoor furnace.

1. Collect a small sample of the water to be used to fill the outdoor furnace in a clean container.
2. Dip the pH test strip from the provided test kit in the water sample. Shake excess water off the test strip. Compare the color of the test strip to the chart provided to determine pH level.
3. If the pH level is between 6.5 and 8.0 and there are no other known water quality problems, then the outdoor furnace may be filled with this water.
4. Water that has a pH level of less than 6.5 or greater than 8.0, or that has other known water quality problems, should not be used to fill the furnace. Instead, water should be supplied from a different source.

2. Check the Vent Cap

If the vent cap has been secured with a wire tie-down, the wire tie-down **MUST** be removed before operating the furnace. If the vent cap is held in place by a spring retainer, the spring retainer can be left in place. The vent cap must fit loosely over the outdoor furnace vent.

3. Check for Leaks

Close the valves on the outdoor furnace before checking for leaks. Do not pressurize the outdoor furnace. Pressure-test the entire plumbing system. Apply 50 psi (3.5 kg/cm²) of air pressure for thirty minutes and closely monitor for any pressure loss. Inspect all fittings and hose ends for any signs of leakage using leak detection solution (leak soap); repair as necessary.

4. Cover Supply and Return Lines

Backfill the trench for the supply and return lines. Enclose the area where the supply and return lines enter the outdoor furnace. Do not leave the PEX hot supply and return lines exposed to sunlight as exposure to UV rays will damage them.

5. Adding Initial Water Treatment

⚠ CAUTION

Avoid damaging your furnace and voiding your warranty. Add water treatment BEFORE adding water to the system. Water treatment in your outdoor furnace is just as important as the oil in a car's engine.

Add MolyArmor 350

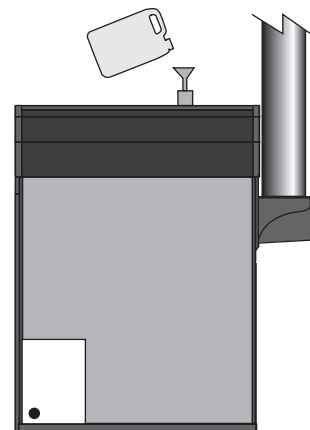

MolyArmor 350 Corrosion Inhibitor (p/n 2900630) gives optimum protection for the furnace water jacket and system parts when it is used to initially treat the water and is maintained at a minimum of 350 ppm of moly and pH level between 8.0 and 9.5. The recommended initial treatment rate for the outdoor furnace is specified by units. One unit of MolyArmor 350 is a 1-gallon (3.78-liter) container.

Refer to your Owner's Manual and write the amount of recommended MolyArmor in the following table.

INITIAL MOLYARMOR 350 CORROSION INHIBITOR TREATMENT AMOUNTS	

1. Add the recommended amount of MolyArmor 350 Corrosion Inhibitor to the outdoor furnace.

NOTE: If the system has a larger than normal water capacity, more MolyArmor 350 should be added at a recommended rate of 6.5 oz. (190 ml) per 10 gallons (37.8 liters) of system water. One unit (1 gallon or 3.78 liters) of MolyArmor 350 Corrosion Inhibitor will treat 200 gallons (757 liters) of system water.

2. Fill the furnace and system using the instructions from Step 6 to ensure air is purged from the system.

6. Fill Outdoor Furnace with Water and Purge Air

NOTE: If adding antifreeze to the system, refer to Adding Antifreeze to Outdoor Furnace System section for important information.

⚠ CAUTION

If using antifreeze, use only a nontoxic boiler-type antifreeze. It is imperative that the entire system contain at least 30% antifreeze concentration mixed with water that is 6.5 to 8.0 pH. Softened water is recommended, if available. Do not use reverse osmosis or deionized water that has very low pH. Be sure to adhere to all warnings and precautions on the antifreeze label.

NOTE: If the outdoor furnace is being filled with water when the temperature is below freezing, circulate the water immediately after filling to prevent freezing the water lines.

NOTE: The circulation pump(s) must be installed in the hot supply line(s).

NOTE: All air must be purged from the water lines when filling the system. Be sure to purge the air from each pump circuit from the outdoor furnace.

Use water from a pressurized domestic water system to fill the outdoor furnace and purge the system of air. Refer to the method for your system, depending on whether or not the optional thermostatic valve has been installed.

If you have installed an optional thermostatic valve, use Option #1. If no thermostatic valve has been installed, use Option #2.

Option #1 - For Systems with Optional Thermostatic Valve Installed

Use this procedure to fill the outdoor furnace with water from a pressurized domestic water system and to purge the air from the system if the optional thermostatic valve has been installed. Be sure to purge the air from each pump circuit from the outdoor furnace. All valves in the outdoor furnace system should be opened before starting this procedure.

NOTE: If using the valve on the water heater to fill the outdoor furnace, flush the water heater to remove all sediment before filling the outdoor furnace.

NOTE: Refer to the illustration when performing these steps.

1. Connect the male end of garden hose A to valve #1 using the backflow preventer and two 3/4" female hose x 3/4" male pipe adapters (p/n 4928). Connect the female end of the garden hose to valve #2.
2. Close the valves on the hot supply and return lines of the outdoor furnace.
3. Close valve #4 and valve #5.
4. Open valve #1 and valve #2. This step begins filling the system with domestic water and purging the hot supply line and thermostatic valve.
5. Remove cap from valve #3 and open valve #3 slightly to purge air from valve body. Close valve #3 when air is purged.
6. Open valve #5.

Filling Outdoor Furnace and Purging Air Using Pressurized Domestic Water

For Systems with Optional Thermostatic Valve Installed

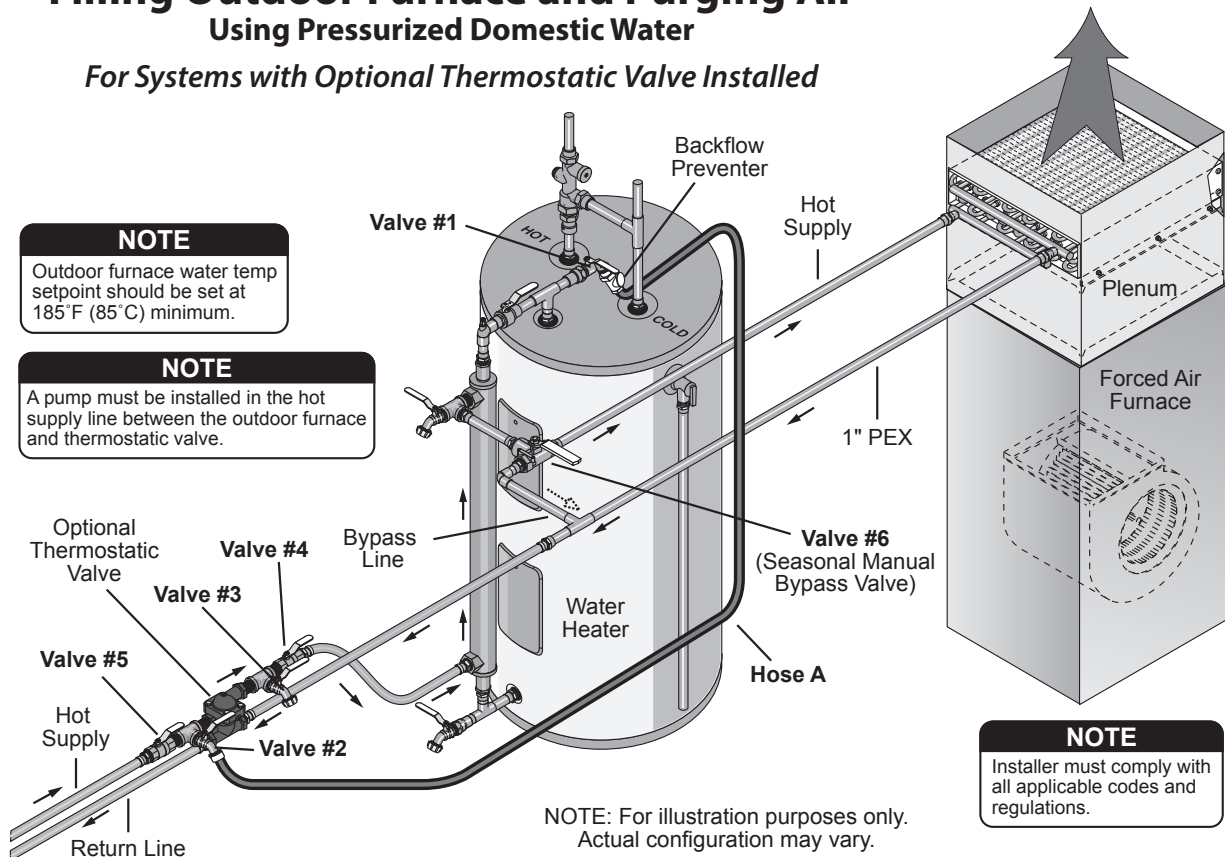

7. Open the valve on the hot supply line of the outdoor furnace for 5 minutes; then close the valve. Water will purge air from the hot supply line. The valve and attached fittings on the outdoor furnace will become cold as water starts filling into outdoor furnace.
8. Close valve #5, #1 and #2.
9. Move hose A from valve #2 to valve #3.
10. Open valves #1, #3 and #4.

NOTE: Skip to Step 12 if your system does not have a seasonal manual bypass valve (valve #6 shown in Fig. 38).

11. Valve #6 (seasonal manual bypass valve) should be positioned to direct water through the heat exchanger first.
12. Open the valve on the return line of the outdoor furnace.

NOTE: Skip to Step 14 if your system does not have a seasonal manual bypass valve (valve #6 shown in Fig. 38).

13. As soon as the valve on the return line of the outdoor furnace is opened, turn valve #6 to the bypass direction for 30 seconds; then turn valve #6 back to previous position.

NOTE: The heat exchanger manifold (lower manifold first) and fittings will become cold as water flows through the heat exchanger to the outdoor furnace.

14. Allow outdoor furnace to fill until the water reaches 1" below the full mark.
15. Close valves #1 and #3. Disconnect hose A and replace caps on valves #1, #2 and #3.
16. Open the valve on the hot supply line of the outdoor furnace and valve #5.

NOTE: The valves on the hot supply and return lines of the outdoor furnace, and valves #4 and #5 should all be open, allowing the pump to circulate heated water in the system. Start pump.

Option # 2 - For Systems without Optional Thermostatic Valve

Use this procedure to fill the outdoor furnace with water from a pressurized domestic water system and to purge the air from the system if the optional thermostatic valve has not been installed. Be sure to purge the air from each pump circuit from the outdoor furnace. All valves in the outdoor furnace system should be opened before starting this procedure.

NOTE: If using the valve on the water heater to fill the outdoor furnace, flush the water heater to remove all sediment before filling the outdoor furnace.

NOTE: Refer to the illustration when performing these steps.

1. Connect a hose with two female ends and a backflow preventer inline to the pressurized domestic water line. Run water into a pail or other container until clear; then connect to the system.
2. Close the valve on the hot supply line of the outdoor furnace.
3. Open the two valves that allow the pressurized domestic water to fill into the system (water will start entering the outdoor furnace through the return line).

Filling Outdoor Furnace and Purging Air Using Valves Installed in the System

For Systems without Optional Thermostatic Valve Installed

NOTE: All valves in the outdoor furnace system should be open before starting. Perform this procedure on each pump circuit from the furnace.

1. Install hose with two female ends and backflow preventer.
2. Close the valve on the outdoor furnace on this line first.
3. Open these valves.
4. Fill for 5 minutes.
5. Close valve on the outdoor furnace on this line while water is still entering.
6. Open valve on the outdoor furnace on this line.
7. Fill for 5 minutes; then repeat process for each pump circuit. Once all pump circuits have been purged, finish filling the outdoor furnace until the water reaches the full mark.

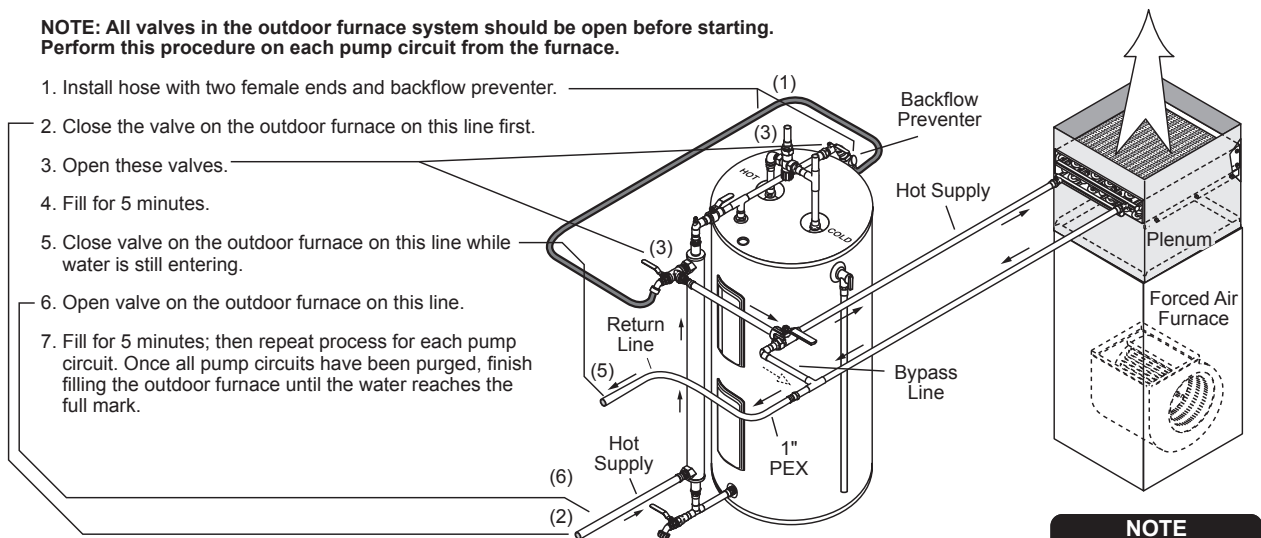

NOTE
Outdoor furnace water temp setpoint should be set at 185°F (85°C) minimum.

NOTE
A pump must be installed in the hot supply line between the outdoor furnace and thermostatic valve.

NOTE: For illustration purposes only. Actual configuration may vary.

NOTE
Installer must comply with all applicable codes and regulations.

4. Refer to the illustration and confirm the direction of the water flow through the system by feeling the temperature along the direction of the system flow at the water lines, heat exchanger and return port on the outdoor furnace. If the parts of the system in the opposite direction are changing temperature, then the supply and return lines are reversed and should be corrected.
5. Let the outdoor furnace fill through the return line for about five minutes.
6. Close the valve on the return line of the outdoor furnace (both valves will now be closed) while the water is still entering the outdoor furnace.
7. Open the valve on the hot supply line of the outdoor furnace. Confirm the flow direction on the supply side (water-to-water heat exchanger and supply port on the outdoor furnace).
8. Fill for 5 minutes; then, if more than one pump circuit is present, close the valves and repeat the process for each pump circuit. Once all pump circuits have been purged with water, continue filling the outdoor furnace until the water level reaches one inch below the FULL mark on the sight gauge to allow for expansion of water as it heats up.
9. Close the two filling valves.
10. Open all valves on the outdoor furnace and turn on the circulation pump(s). This will allow the water to circulate throughout the outdoor furnace system when the pump(s) are operating.

NOTE: At this point, water should not be allowed to circulate through the existing heating system.

7. Immediately Heat the System Water to 185° F (85° C)

⚠ CAUTION

Be sure the outdoor furnace is filled with water before firing. Never fire the outdoor furnace when the water level is more than 1" (2.5 cm) below the FULL mark on the sight gauge.

NOTE: The sight gauge valve should always be closed except when checking water level. Water will automatically drain from the sight gauge tube. Remember that this type of valve requires only 1/4 turn to open or close.

1. Refer to Cold Start Firing in the Owner's Manual to start the outdoor furnace. Bring the water temperature up to operating temperature (185° F or 85° C) for two hours with the system circulating; then add water to the full mark. Continue to run the pump and circulate the water for 24 hours.

NOTE: It is important to bring the water in the system up to operating temperature (i.e., 185° F or 85° C) immediately after filling the system. This also applies any time water is added to the system.

NOTE: If there are multiple circuits connected to the outdoor furnace, repeat the process for each circuit.

⚠ CAUTION

The water in the system may be hot. Use caution and the appropriate personal protective equipment (PPE) when checking for leaks.

2. Check the system for leaks. Inspect all fittings and hose ends for any signs of leakage. Use several dry paper towels and wrap them around and squeeze each fitting, valve and pipe connection. The paper towels will get wet even if there is a very small leak. Immediately repair any leaks to eliminate the need for adding water. If a screw-type clamp has been used, it may be possible to stop a very slow leak at a hose clamp by tightening the clamp after the system has warmed up and the poly becomes more pliable. It might also be necessary to install a second hose clamp with the screw positioned on the opposite side.

NOTE: After a week of operating, use the procedure in step 2 to check the system for leaks again.

NOTE: If water is added, it is important to bring the water in the system up to operating temperature (i.e., 185° F or 85° C) immediately. Refer to Water Quality and Maintenance in the Owner's Manual for water testing procedures. If indicated by test results, add MolyArmor 350 as required. Deterioration due to improper operation and/or maintenance is not covered by warranty.

8. Test the Treated System Water

After circulating the water in the system for 24 hours, test the treated system water for the recommended moly (at least 350 ppm) and pH level (between 8.0 and 9.5).

⚠ CAUTION

The water in the sight gauge may be hot. Use caution when obtaining a sample.

1. To obtain a system water sample, bend the sight gauge tube away from the outdoor furnace. Before collecting the sample, open the valve and drain about a quart of water from the sight gauge tube; then carefully fill the sample container without contaminating the sample. **Be sure to properly install the sight gauge tube and close the valve when finished.** The water in the sight gauge valve and tube will drain when the valve is closed.
2. Dip a pH test strip from the test kit in the water sample. Shake excess water off the test strip. Compare the color of the test strip to the chart provided to determine pH level. The pH of the treated water should be between 8.0 and 9.5.
3. Follow the instructions provided in the water test kit to test the moly level of the treated system water.

Maintenance Levels

Test the pH and moly levels after the first three months and every six months thereafter, and after adding water to furnace.

NOTE: It should not be necessary to add water to the outdoor furnace more frequently than once every twelve months. If it is more frequent, either there is a leak in the system or the outdoor furnace is boiling because of improper operation or maintenance (see Troubleshooting Section in the Owner's Manual). Be sure to locate and repair the problem immediately. Frequently adding water can cause deterioration in the water jacket. Each time water is added, refer to Water Quality and Maintenance in the Owner's Manual for water testing procedures. If indicated by test results, add MolyArmor 350 as required. Deterioration due to improper operation and/or maintenance is not covered by warranty.

9. Titanium Series Models - Send in Water Sample

See the Owner's Manual for more information.



Central Boiler, Inc.

20502 160th Street
Greenbush, MN 56726
CentralBoiler.com